

CP6007-5A, CP6007-RA

User Guide, Rev. 1.0

Doc. ID: 1070-2698

This page has been intentionally left blank

 CP6007-SA, CP6007-RA - USER GUIDE

Disclaimer

Kontron would like to point out that the information contained in this user guide may be subject to alteration, particularly as a result of the constant upgrading of Kontron products. This document does not entail any guarantee on the part of Kontron with respect to technical processes described in the user guide or any product characteristics set out in the user guide. Kontron assumes no responsibility or liability for the use of the described product(s), conveys no license or title under any patent, copyright or mask work rights to these products and makes no representations or warranties that these products are free from patent, copyright or mask work right infringement unless otherwise specified. Applications that are described in this user guide are for illustration purposes only. Kontron makes no representation or warranty that such application will be suitable for the specified use without further testing or modification. Kontron expressly informs the user that this user guide only contains a general description of processes and instructions which may not be applicable in every individual case. In cases of doubt, please contact Kontron.

This user guide is protected by copyright. All rights are reserved by Kontron. No part of this document may be reproduced, transmitted, transcribed, stored in a retrieval system, or translated into any language or computer language, in any form or by any means (electronic, mechanical, photocopying, recording, or otherwise), without the express written permission of Kontron. Kontron points out that the information contained in this user guide is constantly being updated in line with the technical alterations and improvements made by Kontron to the products and thus this user guide only reflects the technical status of the products by Kontron at the time of publishing.

Brand and product names are trademarks or registered trademarks of their respective owners.

©2023 by Kontron Europe GmbH

Kontron Europe GmbH

Gutenbergstraße 2
85737 Ismaning
Germany
www.kontron.com

Intended Use

THIS DEVICE AND ASSOCIATED SOFTWARE ARE NOT DESIGNED, MANUFACTURED OR INTENDED FOR USE OR RESALE FOR THE OPERATION OF NUCLEAR FACILITIES, THE NAVIGATION, CONTROL OR COMMUNICATION SYSTEMS FOR AIRCRAFT OR OTHER TRANSPORTATION, AIR TRAFFIC CONTROL, LIFE SUPPORT OR LIFE SUSTAINING APPLICATIONS, WEAPONS SYSTEMS, OR ANY OTHER APPLICATION IN A HAZARDOUS ENVIRONMENT, OR REQUIRING FAIL-SAFE PERFORMANCE, OR IN WHICH THE FAILURE OF PRODUCTS COULD LEAD DIRECTLY TO DEATH, PERSONAL INJURY, OR SEVERE PHYSICAL OR ENVIRONMENTAL DAMAGE (COLLECTIVELY, "HIGH RISK APPLICATIONS").

You understand and agree that your use of Kontron devices as a component in High Risk Applications is entirely at your risk. To minimize the risks associated with your products and applications, you should provide adequate design and operating safeguards. You are solely responsible for compliance with all legal, regulatory, safety, and security related requirements concerning your products. You are responsible to ensure that your systems (and any Kontron hardware or software components incorporated in your systems) meet all applicable requirements. Unless otherwise stated in the product documentation, the Kontron device is not provided with error-tolerance capabilities and cannot therefore be deemed as being engineered, manufactured or setup to be compliant for implementation or for resale as device in High Risk Applications. All application and safety related information in this document (including application descriptions, suggested safety measures, suggested Kontron products, and other materials) is provided for reference only.

▲ CAUTION

Handling and operation of the product is permitted only for trained personnel within a work place that is access controlled. Please follow the "General Safety Instructions for IT Equipment" supplied with the system.

Revision History

Revision	Brief Description of Changes	Date of Issue	Author/Editor
1.0	Initial Version	2022-May-23	MK

Terms and Conditions

Kontron warrants products in accordance with defined regional warranty periods. For more information about warranty compliance and conformity, and the warranty period in your region, visit <http://www.kontron.com/terms-and-conditions>.

Kontron sells products worldwide and declares regional General Terms & Conditions of Sale, and Purchase Order Terms & Conditions. Visit <http://www.kontron.com/terms-and-conditions>.

For contact information, refer to the corporate offices contact information on the last page of this user guide or visit our website [CONTACT US](#).

Customer Support

Find Kontron contacts by visiting: <http://www.kontron.com/support>.

Customer Service

As a trusted technology innovator and global solutions provider, Kontron extends its embedded market strengths into a services portfolio allowing companies to break the barriers of traditional product lifecycles. Proven product expertise coupled with collaborative and highly-experienced support enables Kontron to provide exceptional peace of mind to build and maintain successful products.

For more details on Kontron's service offerings such as: enhanced repair services, extended warranty, Kontron training academy, and more visit <http://www.kontron.com/support-and-services/services>.

Customer Comments

If you have any difficulties using this user guide, discover an error, or just want to provide some feedback, contact [Kontron support](#). Detail any errors you find. We will correct the errors or problems as soon as possible and post the revised user guide on our website.

Symbols

The following symbols may be used in this user guide

⚠ DANGER

DANGER indicates a hazardous situation which, if not avoided, will result in death or serious injury.

⚠ WARNING

WARNING indicates a hazardous situation which, if not avoided, could result in death or serious injury.

NOTICE

NOTICE indicates a property damage message.

⚠ CAUTION

CAUTION indicates a hazardous situation which, if not avoided, may result in minor or moderate injury.



Electric Shock!

This symbol and title warn of hazards due to electrical shocks (> 60 V) when touching products or parts of products. Failure to observe the precautions indicated and/or prescribed by the law may endanger your life/health and/or result in damage to your material.



ESD Sensitive Device!

This symbol and title inform that the electronic boards and their components are sensitive to static electricity. Care must therefore be taken during all handling operations and inspections of this product in order to ensure product integrity at all times.



HOT Surface!

Do NOT touch! Allow to cool before servicing.



Laser!

This symbol inform of the risk of exposure to laser beam and light emitting devices (LEDs) from an electrical device. Eye protection per manufacturer notice shall review before servicing.



This symbol indicates general information about the product and the user guide.

This symbol also indicates detail information about the specific product configuration.



This symbol precedes helpful hints and tips for daily use.

For Your Safety

Your new Kontron product was developed and tested carefully to provide all features necessary to ensure its compliance with electrical safety requirements. It was also designed for a long fault-free life. However, the life expectancy of your product can be drastically reduced by improper treatment during unpacking and installation. Therefore, in the interest of your own safety and of the correct operation of your new Kontron product, you are requested to conform with the following guidelines.

High Voltage Safety Instructions

As a precaution and in case of danger, the power connector must be easily accessible. The power connector is the product's main disconnect device.

⚠ CAUTION

Warning

All operations on this product must be carried out by sufficiently skilled personnel only.

⚠ CAUTION



Electric Shock!

Before installing a non hot-swappable Kontron product into a system always ensure that your mains power is switched off. This also applies to the installation of piggybacks. Serious electrical shock hazards can exist during all installation, repair, and maintenance operations on this product. Therefore, always unplug the power cable and any other cables which provide external voltages before performing any work on this product.

Earth ground connection to vehicle's chassis or a central grounding point shall remain connected. The earth ground cable shall be the last cable to be disconnected or the first cable to be connected when performing installation or removal procedures on this product.

Special Handling and Unpacking Instruction

NOTICE



ESD Sensitive Device!

Electronic boards and their components are sensitive to static electricity. Therefore, care must be taken during all handling operations and inspections of this product, in order to ensure product integrity at all times.

Do not handle this product out of its protective enclosure while it is not used for operational purposes unless it is otherwise protected.

Whenever possible, unpack or pack this product only at EOS/ESD safe work stations. Where a safe work station is not guaranteed, it is important for the user to be electrically discharged before touching the product with his/her hands or tools. This is most easily done by touching a metal part of your system housing.

It is particularly important to observe standard anti-static precautions when changing piggybacks, ROM devices, jumper settings etc. If the product contains batteries for RTC or memory backup, ensure that the product is not placed on conductive surfaces, including anti-static plastics or sponges. They can cause short circuits and damage the batteries or conductive circuits on the product.

Lithium Battery Precautions

If your product is equipped with a lithium battery, take the following precautions when replacing the battery.

⚠ CAUTION

Danger of explosion if the battery is replaced incorrectly.

- ▶ Replace only with same or equivalent battery type recommended by the manufacturer.
- ▶ Dispose of used batteries according to the manufacturer's instructions.

General Instructions on Usage

In order to maintain Kontron's product warranty, this product must not be altered or modified in any way. Changes or modifications to the product, that are not explicitly approved by Kontron and described in this user guide or received from Kontron Support as a special handling instruction, will void your warranty.

This product should only be installed in or connected to systems that fulfill all necessary technical and specific environmental requirements. This also applies to the operational temperature range of the specific board version that must not be exceeded. If batteries are present, their temperature restrictions must be taken into account.

In performing all necessary installation and application operations, only follow the instructions supplied by the present user guide.

Keep all the original packaging material for future storage or warranty shipments. If it is necessary to store or ship the product then re-pack it in the same manner as it was delivered.

Special care is necessary when handling or unpacking the product. See Special Handling and Unpacking Instruction.

Quality and Environmental Management

Kontron aims to deliver reliable high-end products designed and built for quality, and aims to complying with environmental laws, regulations, and other environmentally oriented requirements. For more information regarding Kontron's quality and environmental responsibilities, visit <http://www.kontron.com/about-kontron/corporate-responsibility/quality-management>.

Disposal and Recycling

Kontron's products are manufactured to satisfy environmental protection requirements where possible. Many of the components used are capable of being recycled. Final disposal of this product after its service life must be accomplished in accordance with applicable country, state, or local laws or regulations.

WEEE Compliance

The Waste Electrical and Electronic Equipment (WEEE) Directive aims to:

- ▶ Reduce waste arising from electrical and electronic equipment (EEE)
- ▶ Make producers of EEE responsible for the environmental impact of their products, especially when the product become waste
- ▶ Encourage separate collection and subsequent treatment, reuse, recovery, recycling and sound environmental disposal of EEE
- ▶ Improve the environmental performance of all those involved during the lifecycle of EEE



Environmental protection is a high priority with Kontron.

Kontron follows the WEEE directive

You are encouraged to return our products for proper disposal.

Table of Contents

Symbols	6
For Your Safety	7
High Voltage Safety Instructions	7
Special Handling and Unpacking Instruction	7
Lithium Battery Precautions	8
General Instructions on Usage	8
Quality and Environmental Management	8
Disposal and Recycling	8
WEEE Compliance	8
Table of Contents	9
List of Tables	11
List of Figures	13
1/ Introduction	14
1.1. Board Overview	14
1.2. System Expansion Capabilities	15
1.2.1. PMC Module	15
1.2.2. XMC Module	15
1.2.3. Rear I/O Module	15
1.2.4. M.2 Storage	15
1.3. Board Diagrams	16
1.3.1. Functional Block Diagram	16
1.3.2. Front Panel	17
1.3.3. Board Layout	18
1.4. Technical Specification	20
1.5. Compliance	25
1.6. Related Publications	26
2/ Functional Description	27
2.1. Processor	27
2.1.1. Graphics Controller	28
2.2. Memory	28
2.3. Watchdog Timer	28
2.4. Battery	28
2.5. Flash Memory	29
2.5.1. SPI Boot Flash for uEFI BIOS	29
2.5.2. M.2 Flash Module	29
2.6. Security Options	29
2.6.1. Trusted Platform Module 2.0	29
2.7. Board Interfaces	30
2.7.1. Front Panel LEDs	30
2.7.2. USB Interfaces	33
2.7.3. DisplayPort Interface	33
2.7.4. Serial Ports	34
2.7.5. Gigabit Ethernet	35
2.7.6. SATA Interfaces	36
2.7.7. M.2 Socket	36
2.7.8. PMC Interface	37
2.7.9. XMC Interface	37

2.7.10. CompactPCI Interface.....	38
2.7.11. CompactPCI Connectors.....	40
3/ Configuration	50
3.1. DIP Switch Configuration.....	50
3.1.1. DIP Switch SW3.....	50
3.1.2. DIP Switch SW4.....	51
3.2. System Write Protection.....	51
3.3. CP6007-Specific Registers.....	51
3.3.1. Write Protection Register (WPROT).....	52
3.3.2. Reset Status Register (RSTAT).....	53
3.3.3. Board ID High Byte Register (BIDH).....	54
3.3.4. Geographic Addressing Register (GEOAD).....	54
3.3.5. Watchdog Timer Control Register (WTIM).....	55
3.3.6. Board ID Low Byte Register (BIDL).....	56
3.3.7. LED Configuration Register (LCFG).....	56
3.3.8. LED Control Register (LCTRL).....	57
3.3.9. General Purpose Output Register (GPOUT).....	57
3.3.10. General Purpose Input Register (GPIN).....	58
4/ Power Considerations.....	59
4.1. System Power.....	59
4.1.1. CP6007 Voltage Ranges.....	59
4.1.2. Power Supply Units.....	59
4.2. Power Consumption.....	61
4.2.1. Power Consumption of the CP6007-SA Accessories.....	62
4.2.2. Power Consumption per Gigabit Ethernet Port.....	63
4.2.3. Power Consumption of PMC Modules.....	63
4.2.4. Power Consumption of XMC Modules.....	63
5/ Thermal Considerations.....	64
5.1. How to read the Temperature Diagrams.....	64
5.2. Volumetric flow rate.....	64
5.3. Airflow.....	64
5.3.1. Peripherals.....	67
6/ Installation.....	68
6.1. Safety.....	68
6.2. General Instructions on Usage.....	68
6.3. Board Installation.....	68
6.3.1. Hot Swap Insertion.....	68
6.3.2. Hot Swap Removal.....	69
6.4. Installation of Peripheral Devices.....	70
6.4.1. SATA M.2 Module Installation.....	71
6.4.2. Installation of External SATA Devices.....	73
6.4.3. PMC Module Installation.....	73
6.4.4. XMC Module Installation.....	73
6.4.5. Rear Transition Module Installation.....	73
6.5. Battery Replacement.....	73
7/ uEFI BIOS.....	74
7.1. Starting the uEFI BIOS.....	74
7.2. Setup Menus.....	75
7.2.1. Main Setup Menu.....	75

7.2.2. Advanced Setup Menu	76
7.2.3. Security Setup Menu	77
7.2.4. Boot Setup Menu	78
7.2.5. Exit Setup Menu	79
7.3. The uEFI Shell.....	80
7.3.1. Introduction, Basic Operation	80
7.3.2. Kontron-Specific uEFI Shell Commands.....	81
7.4. uEFI Shell Scripting	82
7.4.1. Startup Scripting	82
7.4.2. Create a Startup Script.....	82
7.4.3. Examples of Startup Scripts.....	82
7.5. Firmware Update	84
7.5.1. Updating the uEFI BIOS.....	84
7.5.2. Updating the IPMI Firmware.....	86
8/ IPMI Firmware.....	87
8.1. Overview	87
8.2. IPMI Firmware and KCS Interface Configuration	87
8.3. Supported IPMI and PICMG Commands.....	88
8.3.1. Standard IPMI Commands	88
8.3.2. PICMG Commands	91
8.4. Firmware Identification.....	92
8.4.1. Get Device ID Command	92
8.4.2. Device Locator Record	93
8.5. Board Control Extensions.....	93
8.5.1. SPI Boot Flash Selection—uEFI BIOS Failover Control (OPEN)	93
8.6. Sensors Implemented on the Board	93
8.6.1. Sensor List	94
8.7. Sensor Thresholds.....	97
8.8. OEM Event/Reading Types	98
8.9. IPMI Firmware Code	99
8.9.1. Firmware Upgrade	99
8.9.2. IPMI Firmware and FRU Data Write Protection	99
8.10. LAN Functions.....	99
9/ Technical Support	100
9.1. Warranty	100
9.2. Returning Defective Merchandise	101
Appendix A: List of Acronyms.....	102
About Kontron	104

List of Tables

Table 1: CP6007 Main Specifications.....	20
Table 2: Environmental Conditions and Compliance.....	25
Table 3: Related Publications	26
Table 4: Features of the Processors Supported on the CP6007-SA/-RA.....	27
Table 5: Watchdog and Temperature Status LEDs' Functions.....	30
Table 6: IPMI and HS LEDs' Functions.....	31
Table 7: General Purpose LEDs' Functions on the CP6007	32
Table 8: POST Code Sequence.....	33
Table 9: POST Code Example.....	33

Table 10: Serial Port Port Connect or J8 Pinout	34
Table 11: Gigabit Ethernet Controller Port Mapping.....	35
Table 12: PMC PCI Frequency Configuration	37
Table 13: CompactPCI PCI / PCI-X Configuration.....	38
Table 14: CompactPCI Bus Connector J1 System Slot Pinout	41
Table 15: CompactPCI Bus Connector J1 Peripheral Slot Pinout.....	42
Table 16: 64-bit CompactPCI Bus Connector J2 System Slot Pinout	43
Table 17: 64-bit CompactPCI Bus Connector J2 Peripheral Slot Pinout.....	44
Table 18: 64-bit CompactPCI Rear I/O Connector J3 Pinout for CP6007-SA.....	45
Table 19: CompactPCI Rear I/O Connector J3 Signals for CP6007-SA.....	46
Table 20: 64-bit CompactPCI Rear I/O Connector J3 Pinout for CP6007-RA.....	46
Table 21: CompactPCI Rear I/O Connector J3 Signals for CP6007-RA.....	47
Table 22: 64-bit CompactPCI Rear I/O Connector J4 Pinout	48
Table 23: CompactPCI Rear I/O Connector J5 Pinout.....	49
Table 24: CompactPCI Rear I/O Connector J5 Signals	49
Table 25: DIP Switch SW3 Functionality	50
Table 26: DIP Switch SW4 Functionality.....	51
Table 27: CP6007-Specific Registers	51
Table 28: Write Protection Register (WPROT).....	52
Table 29: Reset Status Register (RSTAT)	53
Table 30: Board ID High Byte Register (BIDH).....	54
Table 31: Geographic Addressing Register (GEOAD).....	54
Table 32: Watchdog Timer Control Register (WTIM)	55
Table 33: Board ID Low Byte Register (BIDL)	56
Table 34: LED Configuration Register (LCFG).....	56
Table 35: LED Control Register (LCTRL)	57
Table 36: General Purpose Output Register (GPOUT)	57
Table 37: General Purpose Input Register (GPIN).....	58
Table 38: Operational Input Voltage Range.....	59
Table 39: Workload: uEFI Shell.....	62
Table 40: Workload: Idle (Win 7)	62
Table 41: Workload: Typical	62
Table 42: Workload: Maximum	62
Table 43: Power Consumption of CP6007-SA Accessories.....	62
Table 44: Power Consumption per Gigabit Ethernet Port	63
Table 45: PMC Module Current	63
Table 46: XMC Module Current.....	63
Table 47: Navigation Hot Keys Available in the Legend Bar.....	74
Table 48: Main Setup Menu Functions.....	75
Table 49: Advanced Setup Menu Sub-Screens and Functions	76
Table 50: Security Setup Menu Functions.....	77
Table 51: Boot Priority Order.....	78
Table 52: Exit Setup Menu Functions.....	79
Table 53: Kontron-Specific uEFI Shell Commands	81
Table 54: Standard IPMI Commands.....	88
Table 55: Supported PICMG Commands	91
Table 56: Get Device ID Command	92
Table 57: Sensor List.....	94
Table 58: Thresholds – Standard Temperature Range (CP6007-SA) and Extended Temperature Range (CP6007-RA).....	97
Table 59: Voltage Sensor Thresholds.....	97
Table 60: OEM Event/Reading Types	98
Table 61: List of Acronyms.....	102

List of Figures

Figure 1: CP6007 Functional Block Diagram	16
Figure 2: 4 HP CP6007 Front Panel.....	17
Figure 3: 4 HP CP6007 Board Layout (Top View)	18
Figure 4: 4 HP CP6007 Board Layout (Bottom View).....	19
Figure 5: Serial Port Connect or J8	34
Figure 6: M.2 Connector.....	36
Figure 7: Compact PCI Connectors	40
Figure 8: Location of DIP Switch SW3 and SW4	50
Figure 9: Ambient Temperature for Xeon® W-11865MRE, measured by Intel PTU Tool for Broadwell-DE rev. 1.1.....	65
Figure 10: Ambient Temperature for Xeon® W-11555MRE, measured by Intel PTU Tool for Broadwell-DE rev. 1.1.....	66
Figure 11: CP6007-SA with M.2 card and heat sink installed	70
Figure 12: CP6007-RA with M.2 card installed, without heat sink	70
Figure 13: Installing a M.2 Card	71
Figure 14: Removing a M.2 Card.....	72
Figure 15: CP6007-SA with PMC/XMC Module installed (marked red)	73

1/ Introduction

1.1. Board Overview

CP6007-SA is based on Intel's 11th Gen Xeon® processors with 10nm technology, with outstanding performance-per-watt values. Its scalable power budget allows users to tailor the power dissipation to their requirements. CP6007 is well suited for general computing and as well for advanced Multi-CPU server applications, built as virtual machines and based on PICMG2.16. By using virtualization, any CP6007 based platform becomes a future proof investment.

CP6007 comes in two variants, standard air-cooled CP6007-SA and rugged air-cooled CP6007-RA. CP6007-SA is designed for rather standard environments from 0°C to +60°C, featured by up to 64GB memory with Error Correction Code (ECC) support. CP6007-RA is designed for harsh air-cooled environments, following VITA47 with high shock and vibration demands and temperature ranges from -40 °C to +70 °C. CP6007-RA is equipped with 32 GB soldered memory.

CP6007 is featured by a rich selection of communication and media interfaces. A Trusted Platform Module (TPM 2.0) stands for enhanced hardware and software based data and system security. CP6007 is prepared to operate with different storage devices: onboard industrial grade M.2 flash devices, NVMe as well as SATA, or 2.5 inch SATA hard disk or SSD to be placed on a respective rear-I/O module. CP6007 also features an XMC site according to XMC.3 supporting x8 PCI Express®, and alternatively a PMC site, for various market available extensions. Based on the Kontron rear I/O concept, the rear I/O transition module series is fully functional with CP6007-SA.

CP6007 is widely backward compatibility to earlier Kontron blades. The well-established CompactPCI® eco system, combined with a long availability of the 11th Gen Intel® Xeon® processor family, and Kontron's reliable technical support, make CP6007-SA a safe choice.

The board is offered with various board support packages including Windows and Linux operating systems. For further information concerning the operating systems available for the CP6007, please contact Kontron.

1.2. System Expansion Capabilities

1.2.1. PMC Module

The CP6007 has a 3.3 V, PMC mezzanine interface configurable for 64-bit / 66 MHz PCI operation. This interface supports a wide range of PMC modules with PCI interface including all of Kontron's PMC modules and provides an easy and flexible way to configure the CP6007 for various application requirements. For information on the PMC interface, refer to Chapter 2.7.7, "PMC Interface".

1.2.2. XMC Module

The CP6007 has one XMC mezzanine interface for support of x1, x4 and x8 PCI Express 2.0 XMC modules providing an easy and flexible way to configure the CP6007 for various application requirements. For information on the XMC interface, refer to Chapter 2.7.8, "XMC Interface".

1.2.3. Rear I/O Module

The CP6007 provides support for one rear I/O module via the CompactPCI rear I/O connectors. For further information refer to 2.7.10 "CompactPCI Interface".

1.2.4. M.2 Storage

CP6007 provides support for SATA/NVMe SSD Flash memory in combination with an optional M.2 storage device, connected to a respective onboard connector. Market available M.2 devices of suitable size and keying currently provide storage capacities of 32 GB up to 1 TB. For further information about the M.2 Flash module, refer to Chapter 2.7.6 "SATA Interfaces" and 2.7.7 "M.2 Socket".

1.3. Board Diagrams

The following diagrams provide additional information concerning board functionality and component layout.

1.3.1. Functional Block Diagram

Figure 1: CP6007 Functional Block Diagram

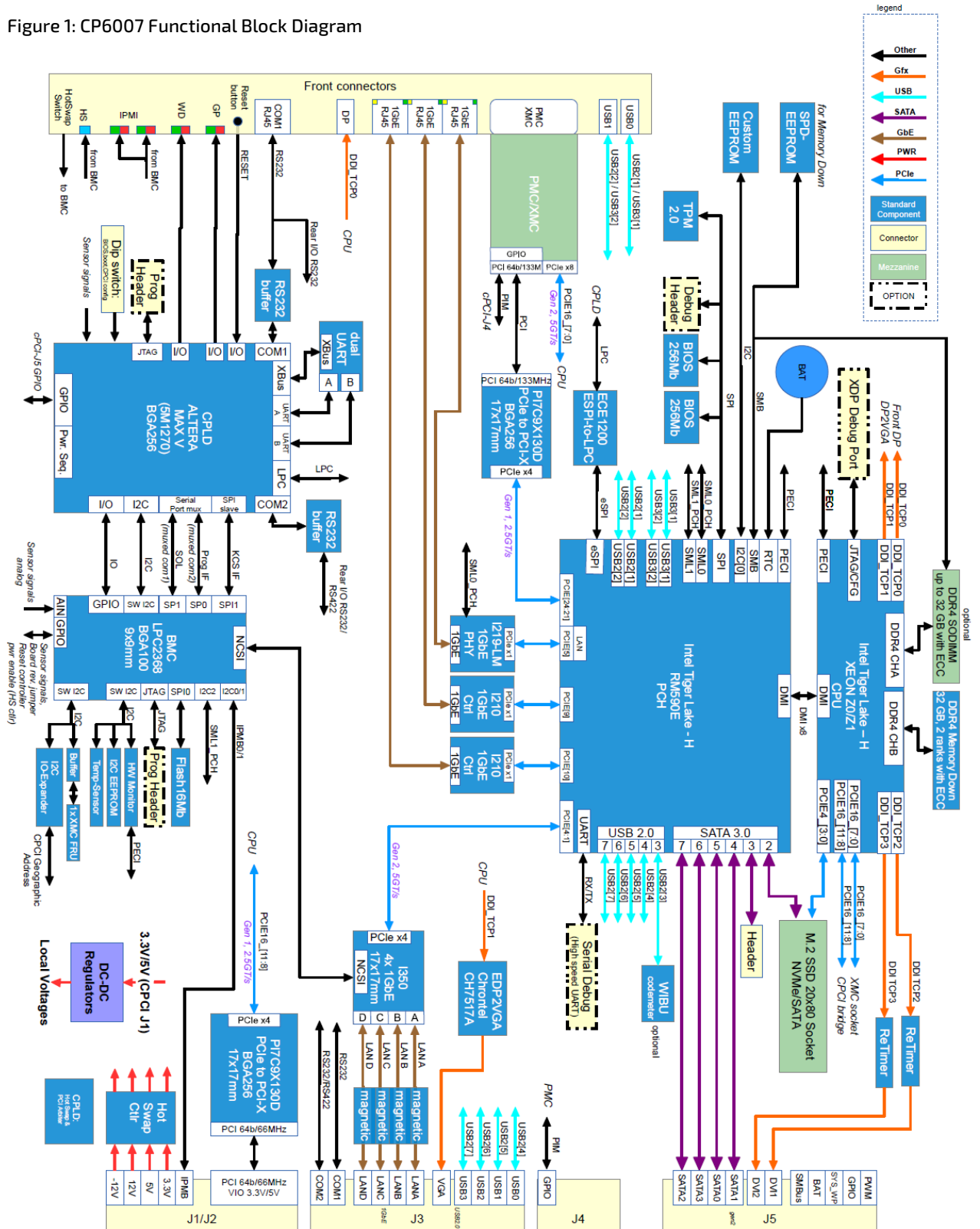

1.3.2. Front Panel

Figure 2: 4 HP CP6007 Front Panel

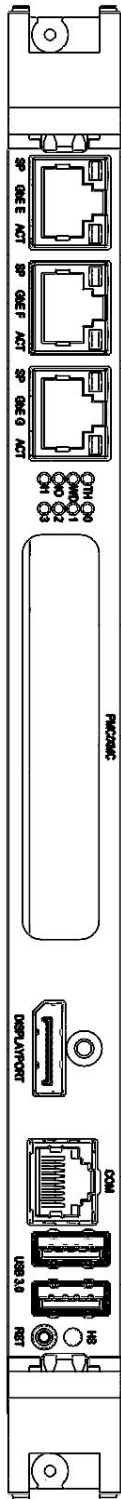

IPMI LEDs

I0/I1 (red/green): Indicate the software status of the IPMI controller

System Status LEDs

HS (blue): Hot Swap Status
 TH (red/green): Temperature Status
 WD (green): Watchdog Status

General Purpose LEDs

LED3-0 (red/green/amber): General Purpose / POST Code

Note: If the General Purpose LEDs 3-0 are lit red during boot-up, a failure is indicated before the uEFI BIOS has started.

Integral Ethernet LEDs

ACT (green): Ethernet Link/Activity
 SPEED (orange): 1000BASE-T Ethernet Speed
 SPEED (green): 100BASE-TX Ethernet Speed
 SPEED (off) + ACT (on): 10BASE-T Ethernet Speed

1.3.3. Board Layout

Figure 3: 4 HP CP6007 Board Layout (Top View)

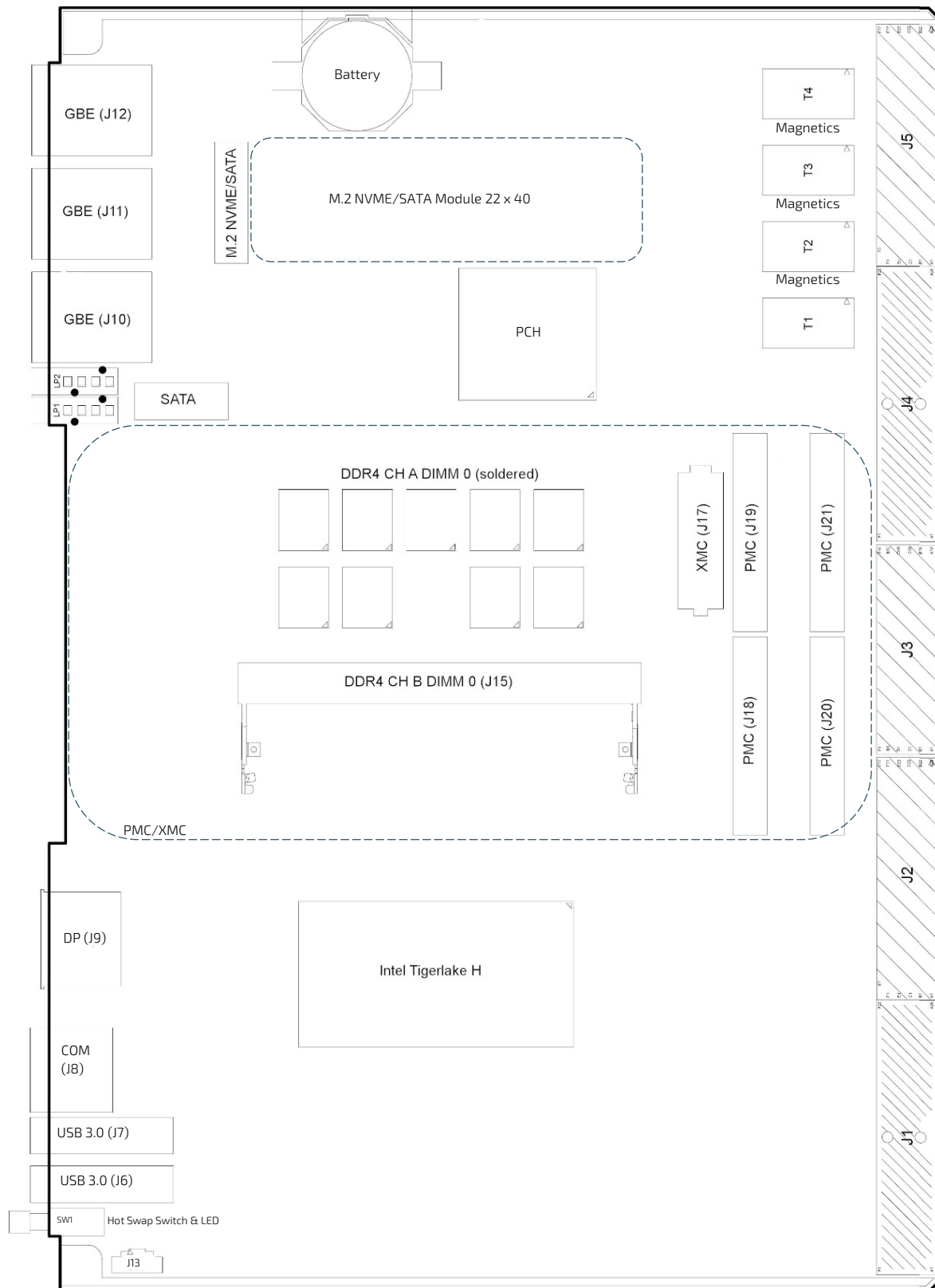
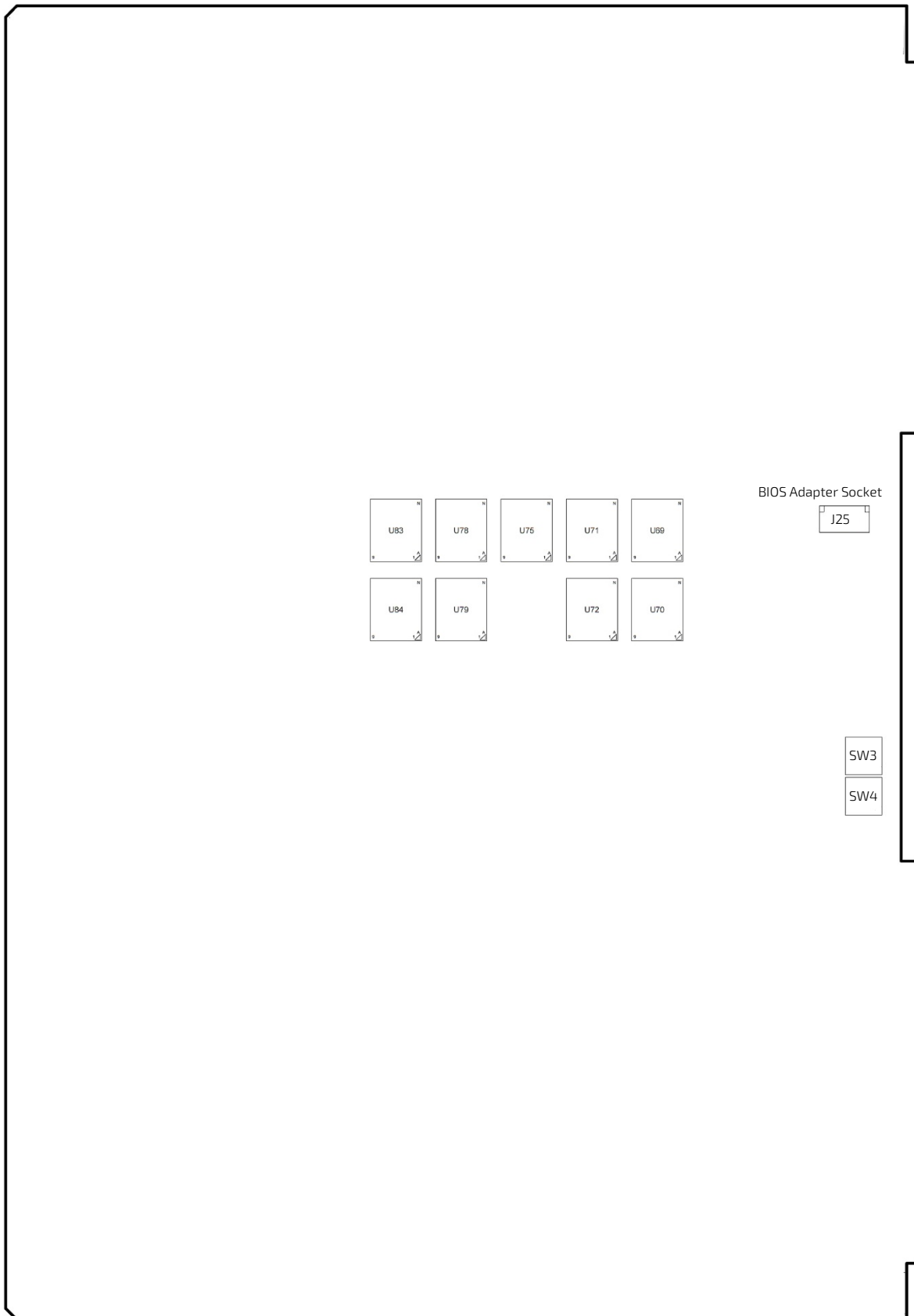

Figure 4: 4 HP CP6007 Board Layout (Bottom View)



1.4. Technical Specification

Table 1: CP6007 Main Specifications

Processor & Chipset	
Processor	<p>The CP6007 supports the following 11th Gen Intel® Xeon® processors:</p> <ul style="list-style-type: none"> ▶ W-11555MRE, 6 core, 12 MByte cache, 2.6 GHz 45 W (TDP), 2.1 GHz 35 W (cTDP) ▶ W-11865MRE, 8 core, 24 MByte cache, 2.6 GHz 45 W (TDP), 2.1 GHz 35 W (cTDP) ▶ Chipset RM590E
Memory	
System Memory	<ul style="list-style-type: none"> ▶ 32 GByte soldered RAM with ECC and data speed of up to 3200 MHz ▶ CP6007-SA only: 32 GByte SODIMM as additional option, dual channel DDR4 with ECC, up to 3200 MHz
Flash Memory	<ul style="list-style-type: none"> ▶ Sockets NVMe and SATA for alternative use, for M.2 2280 Solid State Drive ▶ Two redundant 32 MByte SPI Flashes
EEPROM	EEPROM with 64 kbit
Interfaces	
CompactPCI	<p>CompactPCI interface:</p> <ul style="list-style-type: none"> ▶ Compliant with CompactPCI Specification PICMG 2.0 Rev. 3.0: <ul style="list-style-type: none"> ▶ System controller operation ▶ 64-bit / 66 MHz PCI or PCI-X master interface with dedicated PCIe-to-PCI-X bridge ▶ 3.3V or 5V signaling levels (universal signaling support) ▶ Compliant with the Packet Switching Specification PICMG 2.16 <p>The CP6007 supports System Master hot swap functionality and application-dependent hot swap functionality when used in a peripheral slot.</p> <p>When used as a System Master, the CP6007 supports individual clocks for each slot and the ENUM signal handling is in compliance with the PICMG 2.1 Hot Swap Specification.</p> <p>When installed in a peripheral slot, the CP6007 is isolated from the CompactPCI bus. It receives power from the backplane and supports rear I/O and, if the system supports it, packet switching (in this case up to two channels of Gigabit Ethernet).</p>
Standard Rear I/O	<p>The following interfaces are routed to the rear I/O connectors J3, J4 and J5. COMA (RS-232 signaling) and COMB (RS-232/RS-422 signaling); no buffer on the rear I/O module is necessary</p> <ul style="list-style-type: none"> ▶ 4 x USB 2.0 ▶ 1 x CRT VGA, 2 x DVI/HDMI ▶ 2 x Gigabit Ethernet (compliant with PICMG 2.16, R 1.0) CP6007-RA: 2 additional GbE (J3) ▶ 4 x SATA 3 Gb/s (up to) ▶ 4 x GPIs and 4 GPOs (LVTTL signaling)

Interfaces	
Gigabit Ethernet	<p><u>CP6007-SA</u></p> <p>Five 10 Base-T/100 Base-TX/1000 Base-T Gigabit Ethernet interfaces based on two Intel® I210-IT Gigabit Ethernet controllers, one Intel® I219 Gigabit Ethernet controller and one Intel® I350 quad-port Gigabit Ethernet controller (only two ports used):</p> <ul style="list-style-type: none"> ▶ Three RJ-45 connectors on the front panel ▶ Two ports on the rear I/O (PICMG 2.16)
Gigabit Ethernet	<p><u>CP6007-RA</u></p> <p>Seven 10 Base-T/100 Base-TX/1000 Base-T Gigabit Ethernet interfaces based on two Intel® I210-IT Gigabit Ethernet controller, one Intel® I219 Gigabit Ethernet controller and one Intel® I350 quad-port Gigabit Ethernet controller:</p> <ul style="list-style-type: none"> ▶ Three RJ-45 connectors on the front panel ▶ Four ports on the rear I/O (PICMG 2.16)
USB	<p>Six USB ports supporting UHCI (USB 1.1), EHCI (USB 2.0) and XHCI (USB 3.0):</p> <ul style="list-style-type: none"> ▶ Two type A USB 3.0 connectors on the front panel ▶ Four USB 2.0 ports on the rear I/O interface
Serial	<p>Two 16C550-compatible UARTs:</p> <ul style="list-style-type: none"> ▶ One RS-232 port on the front panel and routed to rear I/O, COM1 ▶ One RS-232/RS-422 port on the rear I/O, COM2
PMC/XMC	<ul style="list-style-type: none"> ▶ One 64-bit / 66 MHz PMC slot, Pn1-Pn4, 3.3 volt V(I/O) ▶ Alternatively one XMC slot via P15, supporting XMC.3 x8 PCI Express®
SATA	<ul style="list-style-type: none"> ▶ Four ports to rear I/O (SATA 3Gb/s) ▶ One standard SATA 6Gb/s connector ▶ One mounting option for M.2 2280 SSD flash (SATA 6Gb/s)

Sockets	
Front Panel Connectors	<ul style="list-style-type: none"> ▶ DisplayPort: one DP connector, J9 ▶ USB: two 4-pin, type A connectors, J6 and J7 ▶ Ethernet: three 8-pin, RJ-45 connectors, J10, J11 and J12 ▶ Serial port: one 8-pin, RJ-45 connector, J8 (COMA) ▶ XMC front panel bezel cutout
Onboard Connectors	<ul style="list-style-type: none"> ▶ One XMC connector, J20 ▶ Two SATA connectors <ul style="list-style-type: none"> ▶ One 7-pin, standard SATA connector, J14 ▶ One M.2 socket (J18) ▶ One JTAG connector, J15 ▶ One XDP-SFF (debug) connector, J19 ▶ Five CompactPCI connectors J1, J2, J3, J4 and J5 ▶ One soldered DDR4 memory bank <ul style="list-style-type: none"> ▶ (CP6007-SA: one additional DDR4 SODIMM socket J15)
LEDs	
Front Panel LEDs	<p>IPMI LEDs:</p> <ul style="list-style-type: none"> ▶ I0/I1 (red/green): Software status of the IPMI controller <p>System Status LEDs:</p> <ul style="list-style-type: none"> ▶ WD (green): Watchdog status ▶ TH (red/green): Temperature status ▶ HS (blue): Hot swap status <p>General Purpose LEDs:</p> <ul style="list-style-type: none"> ▶ LED3-0 (red/green/amber): General purpose / POST code <p>Ethernet LEDs:</p> <ul style="list-style-type: none"> ▶ ACT (green): Network link / activity ▶ SPEED (green/orange): Network speed
Switches	
DIP Switches	Two onboard DIP switches, SW3 and SW4 for board configuration on the rear side of the board
Reset Switch	One hardware reset switch on the front panel
Hot Swap Switch	One switch for hot swap purposes integrated in the front panel in accordance with PICMG 2.1 Rev. 2.0
Timer	
Real-Time Clock	Real-time clock with 256 Byte CMOS RAM; battery-backup available
Watchdog Timer	Software-configurable, two-stage Watchdog with programmable timeout ranging from 125 ms to 4096 s in 16 steps Serves for generating IRQ or hardware reset
System Timer	The Intel® SoC contains three 8254-style counters with fixed uses. In addition to the three 8254-style counters, the Intel® SoC includes eight individual high-precision event timers that may be used by the operating system. They are implemented as a single counter each with its own comparator and value register.

IPMI	
IPMI Controller	<p>NXP® ARM7 microcontroller with 512 kB firmware flash and automatic rollback strategy</p> <p>The IPMI controller carries out IPMI commands such as monitoring several onboard temperature conditions, board voltages and the power supply status, and managing hot swap operations.</p> <p>The IPMI controller is accessible via two IPMBs, one host Keyboard Controller Style (KCS) Interface and up to four Gigabit Ethernet Interfaces (IOL).</p>
Thermal	
Thermal Management	<p>CPU and board overtemperature protection is provided by:</p> <ul style="list-style-type: none"> ▶ Temperature sensors integrated in the Intel® SoC: <ul style="list-style-type: none"> ▶ One temperature sensor for monitoring each processor core ▶ One temperature sensor for monitoring the package die temperature ▶ One onboard temperature sensor for monitoring the board temperature ▶ Specially designed heat sink
Security	
TPM	<ul style="list-style-type: none"> ▶ Trusted Platform Module (TPM) 2.0 for enhanced hardware- and software-based data and system security
Software	
uEFI BIOS	<p>AMI Aptio V™ BIOS firmware based on the uEFI Specification and the Intel Platform Innovation Framework for EFI:</p> <ul style="list-style-type: none"> ▶ LAN boot capability for diskless systems (UEFI Networks Stack) ▶ (OPEN) Automatic fail-safe recovery in case of a damaged image ▶ Non-volatile storage of setup settings in the SPI boot flash (battery only required for the RTC) ▶ Command shell for diagnostics ▶ uEFI Shell commands executable from mass storage device in a pre-OS environment (open interface)

Software (continued)	
IPMI Firmware	<p>IPMI firmware providing the following features:</p> <ul style="list-style-type: none"> ▶ Keyboard Controller Style (KCS) interface ▶ Dual-port IPMB interface for out-of-band management and sensor monitoring ▶ IPMI over LAN (IOL) and Serial over LAN (SOL) support ▶ Sensor Device functionality with configurable thresholds for monitoring board voltages, CPU state, board reset, etc. ▶ FRU Inventory functionality ▶ System Event Log (SEL), Event Receiver functionalities ▶ Sensor Data Record Repository (SDRR) functionality ▶ IPMI Watchdog functionality (power-cycle, reset) ▶ Board monitoring and control extensions: <ul style="list-style-type: none"> ▶ Graceful shutdown support ▶ (OPEN) uEFI BIOS fail-over control: selection of the SPI boot flash (standard/recovery) ▶ Field-upgradeable IPMI firmware: <ul style="list-style-type: none"> ▶ via the KCS, IPMB or IOL interfaces ▶ Download of firmware does not break the currently running firmware or payload activities ▶ Two flash banks with rollback capability: manual rollback or automatic in case of upgrade failure
Operating Systems	There are various operating systems available for the CP6007. For further information, please contact Kontron.
General	
Power Consumption	See Chapter 4 for details.
MTBF	T. B. D. hrs acc. to MIL-HDBK-217 FN2 Ground Benign 30 °
Temperature Range	<p>Operational:</p> <p>0 °C to 60 °C Standard (CP6007-SA) -40 °C to +70 °C Extended (CP6007-RA), passive module heat sink, requires forced airflow cooling.</p> <p>Storage:</p> <p>-55 °C to +85 °C (without hard disk and without battery)</p>
Battery	<p>3.0 V lithium battery for RTC with battery socket</p> <p>Battery type: UL-approved CR2025</p> <p>Temperature ranges:</p> <p>Operational (load): -20 °C to +70 °C typical (refer to the battery manufacturer's specifications for exact range)</p> <p>Storage (no load): -40 °C to +70 °C typical</p>
Climatic Humidity	93% RH at 40 °C, non-condensing (acc. to IEC 60068-2-78)
Dimensions	<p>233.35 mm x 160 mm</p> <p>6U, 4 HP, CompactPCI Serial-compliant form factor (6U , 8HP with 4-DIMM option)</p>
Board Weight	<p>CP6007-SA with heat sink: approx. 900 grams</p> <p>CP6007-RA with heat sink: approx. 900 grams</p> <p>The above-mentioned board weight refers to the CP6007 without extension modules (XMC, PMC)</p>

1.5. Compliance

This product complies with the requirements of the following standards.

Table 2: Environmental Conditions and Compliance

Operating Temperature	-0°C to +60°C Some connectors and supercap has operating temperature only 0°C to +70°C, relative humidity (non-condensing) 10 % to 93 % at 40°C
Storage Temperature	-30°C to +85°C relative humidity (non-condensing) 10 % to 93 % at 40°C
Vibration (Sinusoidal)	T.B.D.
Single Shock	T.B.D.
Permanent Shock	T.B.D.
Compliance	CE/UKCA, RoHS II, WEEE

NOTICE

Customers desiring to perform further environmental testing of the CP6007 must contact Kontron for assistance prior to performing any such testing.

Boards without conformal coating must not be exposed to a change of temperature which can lead to condensation. Condensation may cause irreversible damage, especially when the board is powered up again.

Kontron does not accept any responsibility for damage to products resulting from destructive environmental testing

1.6. Related Publications

The following publications contain information relating to this product.

Table 3: Related Publications

Product	Publication
CompactPCI Systems	PICMG 2.0, Rev. 3.0 CompactPCI Specification PICMG 2.16, Rev. 1.0 CompactPCI Packet Switching Backplane Specification PICMG 2.20, Rev. 1.0 CompactPCI Packet Serial Mesh Backplane Specification PICMG 2.9, Rev. 1.0 CompactPCI System Management Specification PICMG 2.1, Rev. 2.0 CompactPCI Hot Swap Specification
	IPMI - Intelligent Platform Management Interface Specification v2.0
	IPMI Firmware User Guide Rev1.0, ID 1055-7522, General Information on the Kontron IPMI Firmware
	Kontron CompactPCI Backplane Manual, ID 24229
XMC Module	ANSI/VITA 42.0-200x XMC Switched Mezzanine Card Auxiliary Standard ANSI/VITA 42.3-2006 XMC PCI Express Protocol Layer Standard IEEE 1386-2001, IEEE Standard for a Common Mezzanine Card (CMC) Family
Platform Firmware	Unified Extensible Firmware Interface (UEFI) Specification, Version 2.7
All Kontron Products	Product Safety and Implementation Guide, ID 1021-9142

2/ Functional Description

2.1. Processor

The CP6007 supports the Intel® Xeon® W-1155MRE and the Intel® Xeon® W-11865MRE processors.

Table 4: Features of the Processors Supported on the CP6007-SA/-RA

FEATURE	Intel® Xeon® W-1155MRE	Intel® Xeon® W-11865MRE
Processor Cores	6	8
Maximum Turbo Frequency	4.5 GHz	4.7 GHz
Hyper-Threading	supported	supported
SpeedStep®	supported	supported
L3 cache	12 MB	24 MB
On-package cache	up to 128 MB	--
DDR4 Memory	up to 128 GB / 3200 MHz	up to 128 GB / 2400 MHz
Configurable Thermal Design Frequency/Power Up	2.6 Ghz/45 W	2.6 Ghz/45 W
Configurable Thermal Design Frequency/Power Down	2.1 GHZ/35 W	2.1 GHZ/35 W
Power Limit Reduction	--	--

For further information about the processors used on the CP6007, please visit the Intel website. For further information concerning the suitability of other Intel processors for use with the CP6007, please contact Kontron.

2.1.1. Graphics Controller

CP6007 provides low-power UHD graphics controllers (CP6007-SA: W-11865MRE; CP6007-RA: W-11555MRE) with video and 2D capability. It supports one DP port on the front panel, and one VGA port and two HDMI/DVI ports at the rear IO connector. All graphics ports can be used simultaneously.

2.2. Memory

CP6007-SA:

- ▶ 32 GByte soldered RAM with ECC and data speed of up to 3200 MHz
- ▶ 32 GByte SODIMM as additional option, dual channel DDR4 with ECC, up to 3200 MHz

CP6007-RA:

- ▶ 32 GByte soldered RAM with ECC and data speed of up to 3200 MHz

NOTICE

Only qualified DDR4 ECC SODIMM modules from Kontron are authorized for use with the CP6007. Replacement of the SODIMM modules by the customer without authorization from Kontron will void the warranty.

2.3. Watchdog Timer

The CP6007 provides a Watchdog timer that is programmable for a timeout period ranging from 125 ms to 4096 s in 16 steps.

The Watchdog timer provides the following modes or operation:

- ▶ Timer-only mode
- ▶ Reset mode
- ▶ Interrupt mode
- ▶ Dual-stage mode

In dual-stage mode, a combination of both interrupt and reset is generated if the Watchdog is not serviced.

2.4. Battery

The CP6007 is provided with an UL-approved CR2025, 3.0 V, "coin cell" lithium battery for the RTC. When a battery is installed, refer to the operational specifications of the battery as this determines the storage temperature of the CP6007.

2.5. Flash Memory

The CP6007 provides flash interfaces for the uEFI BIOS and a M.2 Flash module.

2.5.1. SPI Boot Flash for uEFI BIOS

The CP6007 provides two 256 Mbit SPI boot flashes for two separate uEFI BIOS images, a standard SPI boot flash and a recovery SPI boot flash. The fail-over mechanism for the uEFI BIOS recovery can be controlled via the DIP switch SW3, switch 2.

NOTICE

The uEFI BIOS code and settings are stored in the SPI boot flashes. Changes made to the uEFI BIOS settings are available only in the currently selected SPI boot flash. Thus, switching over to the other SPI boot flash may result in operation with different uEFI BIOS code and settings. Switching flashes while ME is in full operating mode could result in malfunction.

2.5.2. M.2 Flash Module

The M.2 connector (Type 2280) can be used for a SSD flash module for operating system and data.

2.6. Security Options

2.6.1. Trusted Platform Module 2.0

The CP6007 supports the Trusted Platform Module (TPM) 2.0, conceived by TCG (Trusted Computing Group). TPM2.0 is a security chip specifically designed to provide enhanced hardware- and software-based data and system security. TPM2.0 is based on the Infineon SLB9670XQ 2.0 security controller and stores sensitive data such as encryption and signature keys, certificates and passwords, and is able to withstand software attacks to protect the stored information.

2.7. Board Interfaces

2.7.1. Front Panel LEDs

The CP6007 provides three system status LEDs, one Hot Swap Status LED (HS LED), one temperature status LED (TH LED) and one Watchdog status LED (WD LED), as well as two IPMI LEDs (I0 and I1) and four General Purpose/POST code LEDs (LED3–0). Their functionality is described in the following chapters and reflected in the registers mentioned in Chapter 3, Configuration.

2.7.1.1. Watchdog and Temperature Status LEDs

Table 5: Watchdog and Temperature Status LEDs' Functions

LED	COLOR	STATE	FUNCTION
TH LED	red / green	Off	Power failure
		Green	Board in normal operation
		Red	CPU has reached maximum allowable operating temperature and the performance has been reduced
WD LED	red / green	OFF	Watchdog inactive
		Green	Watchdog active, waiting to be triggered
		Red	Watchdog expired

2.7.1.2. IPMI LEDs and HS LED

The IPMI LEDs I0 and I1 show the software status of the IPMI controller. The Hot Swap LED (HS LED) indicates when the board may be extracted. It can be switched on or off by software and may be used, for example, to indicate that the shutdown process is finished and the board is ready for extraction.

Table 6: IPMI and HS LEDs' Functions

LED	COLOR	STATE	FUNCTION
I0 (right)	red	Off	IPMI controller running
		On	IPMI controller out of service or in reset state
		Blinking	IPMI controller firmware upgrade
	green	Pulsing	Traffic on the IPMB bus
I1 (left)	red	On	Health error detected
		Blinking	Health error detected, IPMI controller running showing its heart beat
	Pulsing	Health error detected, KCS interface active	
	green	Off	No health error detected
		Pulsing	KCS interface active
Blinking		IPMI controller running showing its heart beat	
HS LED	blue	Off	Board in normal operation Do not extract the board.
		Blinking	Board hot swap in progress Board is not ready for extraction. Do not actuate the hot swap handle. Blinking pattern: a) Long on, short off: the IPMI controller starts the payload b) Long off, short on: the IPMI controller shuts down the payload Wait until the HS LED stops blinking and remains on to extract the board.
		On	a) Board ready for hot swap extraction, or b) Board has just been inserted in a powered system

NOTICE

The status of the IPMI-controlled LEDs (I0, I1, and HS LED) may be temporarily overwritten by the PICMG-defined "Set FRU LED State" command to implement, for example, a lamp test.

2.7.1.3. General Purpose LEDs

The General Purpose LEDs (LED3–0) are designed to indicate the boot-up POST code after which they are available to the application. If the LED3–0 are lit red during boot-up, a failure is indicated. In this event, please contact Kontron for further assistance.

Table 7: General Purpose LEDs' Functions on the CP6007

LED	COLOR	FUNCTION DURING BOOT-UP	FUNCTION DURING uEFI BIOS POST (if POST code config. is enabled)	FUNCTION AFTER BOOT-UP
LED3	red	Power failure	--	--
	green	--	uEFI BIOS POST bit 3 and bit 7	--
	amber	--	--	--
LED2	red	CPU catastrophic error	CPU catastrophic error	--
	green	--	uEFI BIOS POST bit 2 and bit 6	SATA channels active
	amber	--	--	--
LED1	red	Hardware reset	--	--
	green	--	uEFI BIOS POST bit 1 and bit 5	--
	amber	--	--	--
LED0	red	uEFI BIOS boot failure	--	--
	green	--	uEFI BIOS POST bit 0 and bit 4	--
	amber	--	--	--

For further information regarding the configuration of the General Purpose LEDs, refer to Chapter 3.3.7, LED Configuration Register, and Chapter 3.3.8, LED Control Register.

NOTICE

The bit allocation for Port 80 is the same as for the POST code.

How to Read the 8-Bit POST Code

Due to the fact that only 4 LEDs are available and 8 bits must be displayed, the POST code output is multiplexed on the General Purpose LEDs.

Table 8: POST Code Sequence

STATE	GENERAL PURPOSE LEDs
0	All LEDs are OFF; start of POST sequence
1	High nibble
2	Low nibble; state 2 is followed by state 0

The following is an example of the General Purpose LEDs' operation if the POST configuration is enabled (see also Tables 8 and 9).

Table 9: POST Code Example

	LED3	LED2	LED1	LED0	RESULT
HIGH NIBBLE	off (0)	on (1)	off (0)	off (0)	0x4
LOW NIBBLE	off (0)	off (0)	off (0)	on (1)	0x1
POST CODE	0x41				

NOTICE

Under normal operating conditions, the General Purpose LEDs should not remain lit during boot-up. They are intended to be used only for debugging purposes. In the event that a General Purpose LED lights up during boot-up and the CP6007 does not boot, please contact Kontron for further assistance.

2.7.2. USB Interfaces

The CP6007 provides six USB ports:

- ▶ Two on front I/O (USB 3.0/2.0)
- ▶ Four on the CompactPCI rear I/O interface (USB 2.0)

On the front panel, the CP6007 has two standard, type A, USB 3.0 connectors, J6 and J7.

2.7.3. DisplayPort Interface

The CP6007 provides one standard DisplayPort (DP) interface for connection to a monitor. The DP interface is implemented as a standard DisplayPort connector, J9, on the front panel.

2.7.4. Serial Ports

The CP6007 provides two serial ports:

- ▶ COMA (RS-232) available either on the front panel or on the CompactPCI rear I/O interface
- ▶ COMB (RS-232/RS-422) on the CompactPCI rear I/O interface

COMA and COMB are fully compatible with the 16550 controller. The rear I/O COMA port includes a complete set of handshaking and modem control signals. The COMB port includes RXD, TXD, CTS, and RTS signals.

The COMA and COMB ports provide maskable interrupt generation. The data transfer on the COM ports is up to 115.2 kbit/s.

The serial port COMA is implemented as an 8-pin RJ-45 connector, J8. The following figure and table provide pinout information for the serial connector J8 (COMA).

Figure 5: Serial Port Connect or J8

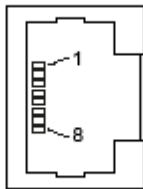

Table 10: Serial Port Port Connect or J8 Pinout

PIN	SIGNAL	DESCRIPTION	I/O
1	RTS	Request To Send	0
2	DTR	Data Terminal Ready	0
3	TXD	Transmit Data	0
4	GND	Signal Ground	--
5	GND	Signal Ground	--
6	RXD	Receive Data	1
7	DSR	Data Send Request	1
8	CTS	Clear To Send	1

2.7.5. Gigabit Ethernet

The CP6007-SA provides five Gigabit Ethernet interfaces. The CP6007-RA provides two further Gigabit Ethernet interfaces in addition to the five interfaces of the -SA variant.

All Gigabit Interfaces are 10Base-T/100Base-T/1000Base-T compliant.

Table 11: Gigabit Ethernet Controller Port Mapping

ETHERNET CONTROLLER	PORT MAPPING	IOL/SOL Channel (IPMI)
Intel i219, Bus 0 Dev 0x1f, Function 6	Front Port J10 (lower connector)	--
Intel i350, Bus 2 Dev 0, Function 0	Rear LAN, PICMG 2.16 LPb	2
Intel i350, Bus 2 Dev 0, Function 1	Rear LAN, PICMG 2.16 LPa	3
Intel i350, Bus 2 Dev 0, Function 2	Rear LAN, J3 LPd (CP6007-RA only)	4
Intel i350, Bus 2 Dev 0, Function 3	Rear LAN, J3 LPc (CP6007-RA only)	5
Intel i210, Bus 3, Dev 0, Function 0	Front Port J11 (middle connector)	--
Intel i210, Bus 4 Dev 0, Function 0	Front Port J12 (upper connector)	--

NOTICE

Listed PCIe bus numbers are valid for a CP6007 board installed in peripheral slot booting from NVMe M.2 module.

Intel i350 and i210 controllers are placed inside PCIe topology behind other optional PCIe devices, which are only enabled if devices are present.

Depending on other PCIe devices, assigned Intel i350 and Intel i210 bus numbers will be different.

Other PCIe devices are (lowest bus numbers listed first):

- ▶ XMC slot (only enabled with installed XMC module)
- ▶ PCIe-PCI-X bridge for CompactPCI backplane (only enabled if board is placed in system slot)
- ▶ NVMe device (not present if SATA M.2 modules are used)
- ▶ PCIe-PCI-X bridge for PMC slot (only enabled if PMC module is present)
- ▶ Intel i350 function 0 – function 3
- ▶ Intel i210 Front J11 (middle)
- ▶ Intel i210 Front J12 (upper)

2.7.6. SATA Interfaces

The CP6007 provides six SATA ports:

- ▶ One SATA 6 Gb/s port on the J18 M.2 socket for mounting a SATA SSD M.2 module
- ▶ One SATA 6 Gb/s port on the standard SATA connector, J14, for connection to SATA devices via cable
- ▶ Four SATA 3 Gb/s ports on the CompactPCI rear I/O interface



In case a RTM Module is present, by default uEFI Bios will limit SATA Speed from 6.0 Gb/s to 1.5Gb/s for all SATA ports, including on board SATA ports.

This behavior can be modified by uEFI Shell kboardconfig SataSpeed command.

Please note that data path via CompactPCI Rear I/O interface is suitable for 3.0Gb/s or slower connections only.

All six SATA interfaces provide high-performance RAID 0/1/5/10 functionality.

2.7.7. M.2 Socket

The CP6007 provides a M.2 socket (J18) to carry SATA/NVMe x4 SSD flash modules. Mounting option for M.2 2280 SSD, PCIe Gen3 x4 flash, M.2 SATA and NVMe mutually exclusive.

Specification:

- ▶ Size: 22x80 mm
- ▶ Keying: "B" or "M"
- ▶ Type: "S" (single sided)
- ▶ Height: from "1" to "4"

Figure 6: M.2 Connector

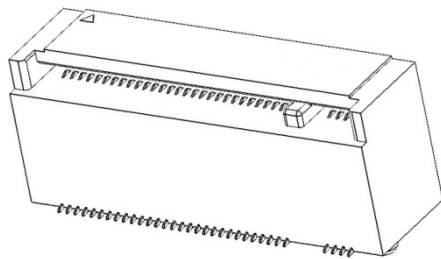

NVMe modules qualified by Kontron:

- ▶ 128 GB Transcend TS128GMTE652TI-KGM
- ▶ 512 GB Transcend TS512GMTE652TI-KGM

2.7.8. PMC Interface

The CP6007 provides one 3.3 V standard PMC interface with a dedicated 32-bit / 66 MHz PCI Express-to-PCI bridge. The PMC interface is compliant with the IEEE 1386.1-2001 specification, which defines a PCI electrical interface for the CMC (Common Mezzanine Card) form factor.

A PMC module can be connected to the CP6007 via the four standard PMC connectors J18, J19, J21 and J22.

Table 12: PMC PCI Frequency Configuration

FREQUENCY	M66EN Signal	DIP SWITCH SW3 SWITCH 4
33 MHz	Low	OFF
33 MHz	--	ON
66 MHz	High	OFF

2.7.9. XMC Interface

For easy and flexible configuration a standard XMC connector, J17, is available. The board uses one x8 PCI Express 2.0 interface operating at 5.0 GT/s and compliant with the ANSI/VITA 42.0 and ANSI/VITA 42.3 specifications. x8 PCI Express 3.0 operating at 8 GT/s is available on request.

2.7.10. CompactPCI Interface

The CP6007 supports a flexibly configurable, hot swap CompactPCI interface. In the system slot the PCI / PCI-X interface is in the transparent mode, and in the peripheral slot the CompactPCI interface is isolated so that it cannot communicate with the CompactPCI bus. This mode is known as "passive mode".

2.7.10.1. Board Functionality when Installed in System Slot

In the system slot, the CompactPCI interface can be either a 64-bit / 66 MHz PCI or PCI-X interface via a dedicated PCI Express-to-PCI-X bridge from Pericom (PI7C9X130D).

The CP6007 supports up to seven peripheral slots with 33 MHz and up to 4 peripheral slots with 66 MHz through a backplane.

The PCI Express-to-PCI-X bridge detects the PCI mode (PCI or PCI-X) and the bus speed (33 MHz or 66 MHz) via two PCI control signals on J1: PCIXCAP (pin B16) and M66EN (pin D21). The following configurations are supported by the CompactPCI interface.

Table 13: CompactPCI PCI / PCI-X Configuration

FREQUENCY	MODE	M66EN J1, PIN D21	PCIXCAP J1, PIN B16	DIP SWITCH SW4 SWITCH 2	DIP SWITCH SW4 SWITCH 1
33 MHz	PCI	Low	Low	OFF	OFF
33 MHz	PCI	--	Low	OFF	ON
66 MHz	PCI	High	Low	OFF	OFF
66 MHz	PCI	High	--	ON	OFF
66 MHz	PCI-X	--	Pull-down resistor	OFF	OFF

NOTICE

To support 66 MHz PCI / PCI-X frequency, the CompactPCI signaling voltage (VI/O) must be 3.3 V.

The CP6007 provides automatic voltage detection for the VI/O to switch the PCI frequency to 33 MHz in an 5V environment.

2.7.10.2. Board Functionality when Installed in Peripheral Slot (Passive Mode)

In a peripheral slot, the board receives power but does not communicate on the CompactPCI bus; all CompactPCI signals are isolated (Drone Mode). In this configuration, the communication is achieved via the two Gigabit Ethernet ports as defined in the PICMG 2.16 specification.

2.7.10.3. Packet Switching Backplane (PICMG 2.16)

The CP6007 supports two Gigabit Ethernet ports on the J3 connector in accordance with the CompactPCI Packet Switching Backplane Specification PICMG 2.16. The two ports are connected in the chassis via the CompactPCI Packet Switching Backplane to the Fabric slots "A" and "B". The PICMG 2.16 feature can be used in the system slot and in the peripheral slot as well.

The CP6007-RA supports two additional Gigabit Ethernet ports on the J3 connector.

2.7.10.4. Hot Swap Support

To ensure that a board may be removed and replaced in a working bus without disturbing the system, the following additional features are required:

- ▶ Power ramping
- ▶ Precharge
- ▶ Hot swap control and status register bits
- ▶ Automatic interrupt generation whenever a board is about to be removed or replaced
- ▶ A Hot Swap LED to indicate that the board may be safely removed

2.7.10.5. Power Ramping

On the CP6007 a special hot swap controller is used to ramp up the onboard supply voltage. This is done to avoid transients on the +3.3V, +5V, +12V and -12V power supplies from the hot swap system. When the power supply is stable, the hot swap controller generates an onboard reset to put the board into a definite state.

2.7.10.6. Precharge

Precharge is provided on the CP6007 by a resistor on each signal line (PCI bus) connected to a +1V reference voltage.

2.7.10.7. Handle Switch

A microswitch is situated in the extractor handle. The status of the handle is included in the onboard logic. The microswitch is connected to the onboard connector J13.

2.7.10.8. ENUM# Interrupt

If the board is operated in the system slot, the ENUM signal is an input.

2.7.10.9. Hot Swap LED

The blue HS LED can be switched on or off by software. It may be used, for example, to indicate that the shutdown process is finished and the board is ready for extraction.

2.7.11. CompactPCI Connectors

The complete CompactPCI connector configuration comprises five standard connectors (2mm Hard Metric) designated as J1, J2, J3, J4 and J5.

Their functions are as follows:

- ▶ J1 and J2: 64-bit CompactPCI interface with PCI bus signals, arbitration, clock and power
- ▶ J3, J4 and J5 with standard rear I/O interface functionality
- ▶ CP6007-SA provides 2x GbE on J3, CP6007-RA provides 4x GbE on J3

The CP6007 is designed for a CompactPCI bus architecture. The CompactPCI standard is electrically identical to the PCI local bus. However, these systems are enhanced to operate in rugged industrial environments and to support multiple slots.

2.7.11.1. Connector Keying

The CompactPCI connector J1 supports guide lugs to ensure a correct polarized mating.

The CP6007 supports universal PCI VI/O signaling voltages with one common termination resistor configuration and includes a PCI VI/O voltage detection circuit. If the PCI VI/O voltage is 5 V, the maximum supported PCI frequency is 33 MHz.

Figure 7: Compact PCI Connectors

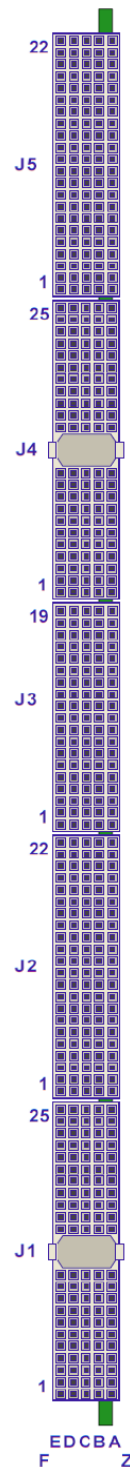

2.7.11.2. CompactPCI Connectors J1 and J2 Pinout

The CP6007 is provided with two 2 mm x 2 mm pitch female CompactPCI bus connectors, J1 and J2.

Table 14: CompactPCI Bus Connector J1 System Slot Pinout

PIN	Z	A	B	C	D	E	F
25	NC	5V	REQ64#	ENUM#	3.3V	5V	GND
24	NC	AD[1]	5V	V(I/O)	AD[0]	ACK64#	GND
23	NC	3.3V	AD[4]	AD[3]	5V	AD[2]	GND
22	NC	AD[7]	GND	3.3V	AD[6]	AD[5]	GND
21	NC	3.3V	AD[9]	AD[8]	M66EN	C/BE[0]#	GND
20	NC	AD[12]	GND	V(I/O)	AD[11]	AD[10]	GND
19	NC	3.3V	AD[15]	AD[14]	GND	AD[13]	GND
18	NC	SERR#	GND	3.3V	PAR	C/BE[1]#	GND
17	NC	3.3V	IPMB SCL	IPMB SDA	GND	PERR#	GND
16	NC	DEVSEL#	PCIXCAP	V(I/O)	STOP#	LOCK#	GND
15	NC	3.3V	FRAME#	IRDY#	BDSSEL#	TRDY#	GND
14-12	Key Area						
11	NC	AD[18]	AD[17]	AD[16]	GND	C/BE[2]#	GND
10	NC	AD[21]	GND	3.3V	AD[20]	AD[19]	GND
9	NC	C/BE[3]#	NC	AD[23]	GND	AD[22]	GND
8	NC	AD[26]	GND	V(I/O)	AD[25]	AD[24]	GND
7	NC	AD[30]	AD[29]	AD[28]	GND	AD[27]	GND
6	NC	REQ0#	CPCI_Present#	3.3V	CLK0	AD[31]	GND
5	NC	RSV	RSV	RST#	GND	GNT0#	GND
4	NC	IPMB PWR	Health#	V(I/O)	RSV	RSV	GND
3	NC	INTA#	INTB#	INTC#	5V	INTD#	GND
2	NC	TCK	5V	TMS	NC	TDI	GND
1	NC	5V	-12V	TRST#	+12V	5V	GND

Table 15: CompactPCI Bus Connector J1 Peripheral Slot Pinout

PIN	Z	A	B	C	D	E	F
25	NC	5V	*	*	3.3V	5V	GND
24	NC	*	5V	V(I/O)	*	*	GND
23	NC	3.3V	*	*	5V	*	GND
22	NC	*	GND	3.3V	*	*	GND
21	NC	3.3V	*	*	*	*	GND
20	NC	*	GND	V(I/O)	*	*	GND
19	NC	3.3V	*	*	GND	*	GND
18	NC	*	GND	3.3V	*	*	GND
17	NC	3.3V	IPMB SCL	IPMB SDA	GND	*	GND
16	NC	*	*	V(I/O)	*	*	GND
15	NC	3.3V	*	*	BDSEL#	*	GND
14-12	Key Area						
11	NC	*	*	*	GND	*	GND
10	NC	*	GND	3.3V	*	*	GND
9	NC	*	NC	*	GND	*	GND
8	NC	*	GND	V(I/O)	*	*	GND
7	NC	*	*	*	GND	*	GND
6	NC	*	CPCI_Present#	3.3V	*	*	GND
5	NC	RSV	RSV	RST#**	GND	*	GND
4	NC	IPMB PWR	Healthy#	V(I/O)	RSV	RSV	GND
3	NC	*	*	*	5V	*	GND
2	NC	TCK	5V	TMS	NC	TDI	GND
1	NC	5V	-12V	TRST#	+12V	5V	GND

NOTICE

A * indicates that the signal normally present at this pin is disconnected from the CompactPCI bus when the CP6007 is inserted in a peripheral slot.

** When the CP6007 is inserted in a peripheral slot, the function of the RST# signal can be enabled or disabled.

Table 16: 64-bit CompactPCI Bus Connector J2 System Slot Pinout

PIN	Z	A	B	C	D	E	F
22	NC	GA4	GA3	GA2	GA1	GA0	GND
21	NC	CLK6	GND	RSV	RSV	RSV	GND
20	NC	CLK5	GND	RSV	GND	RSV	GND
19	NC	GND	GND	IPMB2_SDA	IPMB2_SCL	IPMB2_Alert	GND
18	NC	RSV	RSV	RSV	GND	RSV	GND
17	NC	RSV	GND	PRST#	REQ6#	GNT6#	GND
16	NC	RSV	RSV	DEG#	GND	RSV	GND
15	NC	RSV	GND	FAL#	REQ5#	GNT5#	GND
14	NC	AD[35]	AD[34]	AD[33]	GND	AD[32]	GND
13	NC	AD[38]	GND	V(I/O)	AD[37]	AD[36]	GND
12	NC	AD[42]	AD[41]	AD[40]	GND	AD[39]	GND
11	NC	AD[45]	GND	V(I/O)	AD[44]	AD[43]	GND
10	NC	AD[49]	AD[48]	AD[47]	GND	AD[46]	GND
9	NC	AD[52]	GND	V(I/O)	AD[51]	AD[50]	GND
8	NC	AD[56]	AD[55]	AD[54]	GND	AD[53]	GND
7	NC	AD[59]	GND	V(I/O)	AD[58]	AD[57]	GND
6	NC	AD[63]	AD[62]	AD[61]	GND	AD[60]	GND
5	NC	C/BE[5]#	NC	V(I/O)	C/BE[4]#	PAR64	GND
4	NC	V(I/O)	RSV	C/BE[7]#	GND	C/BE[6]#	GND
3	NC	CLK4	GND	GNT3#	REQ4#	GNT4#	GND
2	NC	CLK2	CLK3	SYSEN#	GNT2#	REQ3#	GND
1	NC	CLK1	GND	REQ1#	GNT1#	REQ2#	GND

Table 17: 64-bit CompactPCI Bus Connector J2 Peripheral Slot Pinout

PIN	Z	A	B	C	D	E	F
22	NC	GA4	GA3	GA2	GA1	GA0	GND
21	NC	*	GND	RSV	RSV	RSV	GND
20	NC	*	GND	RSV	GND	RSV	GND
19	NC	GND	GND	IPMB2_SDA	IPMB2_SCL	IPMB2_Alert	GND
18	NC	RSV	RSV	RSV	GND	RSV	GND
17	NC	RSV	GND	*	*	*	GND
16	NC	RSV	RSV	DEG#	GND	RSV	GND
15	NC	RSV	GND	FAL#	*	*	GND
14	NC	*	*	*	GND	*	GND
13	NC	*	GND	V(I/O)	*	*	GND
12	NC	*	*	*	GND	*	GND
11	NC	*	GND	V(I/O)	*	*	GND
10	NC	*	*	*	GND	*	GND
9	NC	*	GND	V(I/O)	*	*	GND
8	NC	*	*	*	GND	*	GND
7	NC	*	GND	V(I/O)	*	*	GND
6	NC	*	*	*	GND	*	GND
5	NC	*	NC	V(I/O)	*	*	GND
4	NC	V(I/O)	RSV	*	GND	*	GND
3	NC	*	GND	*	*	*	GND
2	NC	*	*	SYSEN#	*	*	GND
1	NC	*	GND	*	*	*	GND

NOTICE

A * indicates that the signal normally present at this pin is disconnected from the CompactPCI bus when the CP6007 is inserted in a peripheral slot.

2.7.11.3. CompactPCI Rear I/O Connectors J3, J4 and J5 Pinout

The CP6007 board provides rear I/O connectivity for peripherals. Standard PC interfaces are implemented and assigned to the front panel and to the rear I/O connectors J3, J4 and J5.

When the rear I/O module is used, the signals of some of the main board/front panel connectors are routed to the module interface. Thus, the rear I/O module makes it much easier to remove the CPU in the rack as there is practically no cabling on the CPU board.

For the system rear I/O feature a special backplane is necessary. The CP6007 with rear I/O is compatible with all standard 6U CompactPCI passive backplanes with rear I/O support.

The CP6007 conducts all standard rear I/O signals through the J3, J4 and J5 connectors.

Table 18: 64-bit CompactPCI Rear I/O Connector J3 Pinout for CP6007-SA

PIN	Z	A	B	C	D	E	F
19	NC	RIO_VCC	RIO_VCC	RIO_3.3V	RIO_+12V	RIO_-12V	GND
18	NC	LPa_DA+	LPa_DA-	GND	LPa_DC+	LPa_DC-	GND
17	NC	LPa_DB+	LPa_DB-	GND	LPa_DD+	LPa_DD-	GND
16	NC	LPb_DA+	LPb_DA-	GND	LPb_DC+	LPb_DC-	GND
15	NC	LPb_DB+	LPb_DB-	GND	LPb_DD+	LPb_DD-	GND
14	NC	LPa:LINK	LPb:LINK	LPab:CT1	RSV	RSV (FAN:SEN2)	GND
13	NC	LPa:ACT	LPb:ACT	NC	NC	RSV (FAN:SEN1)	GND
12	NC	NC	NC	GND	NC	NC	GND
11	NC	NC	NC	GND	NC	NC	GND
10	NC	USB1:VCC	USB0:VCC	GND	USB3:VCC	USB2:VCC	GND
9	NC	USB1:D-	USB1:D+	GND	USB3:D-	USB3:D+	GND
8	NC	USB0:D-	USB0:D+	GND	USB2:D-	USB2:D+	GND
7	NC	RIO_3.3V	GPIO	GPI1	GPI2	SPEAKER	GND
6	NC	VGA:RED	VGA:GREEN	VGA:SDA	DEBUG:CLK	DEBUG:DAT	GND
5	NC	VGA:BLUE	VGA:HSYNC	VGA:VSYNC	VGA:SCL	NC	GND
4	NC	NC	NC	SPB:RX-/CTS	SPB:TX-/TXD	NC	GND
3	NC	SPB:TX+/RTS	SPB:RX+/RXD	NC	NC	NC	GND
2	NC	SPA:RI	SPA:DTR	SPA:CTS	SPA:TXD	NC	GND
1	NC	SPA:RTS	SPA:RXD	SPA:DSR	SPA:DCD	RIO_ID1	GND

NOTICE

The RIO_XXX signals are power supply OUTPUTS to supply the rear I/O module with power. These pins **MUST NOT** be connected to any other power source, either within the backplane itself or within a rear I/O module.

Failure to comply with the above will result in damage to your board.

Table 19: CompactPCI Rear I/O Connector J3 Signals for CP6007-SA

NOTICE

The RIO_XXX signals are power supply **OUTPUTS** to supply the rear I/O module with power. These pins **MUST NOT** be connected to any other power source, either within the backplane itself or within a rear I/O module.
Failure to comply with the above will result in damage to your board.

SIGNAL	DESCRIPTION
SPA	COMA signaling (RS-232)
SPB	COMB signaling (RS-422/RS-232)
VGA	Graphic signaling
USB0 to USB3	USB port signaling
SPEAKER	Standard PC speaker
FAN	Fan speed sensing
DEBUG	Debug output
LPa	Rear I/O LAN Port A
LPb	Rear I/O LAN Port B
GPIO	General purpose digital input/output; 3.3 V only

NOTICE

COMA can be used either on the front panel or on the rear I/O. It is not possible to use COMA on the front panel and on the rear I/O simultaneously.

Table 20: 64-bit CompactPCI Rear I/O Connector J3 Pinout for CP6007-RA

PIN	Z	A	B	C	D	E	F
19	NC	RIO_5V	RIO_5V	RIO_3.3V	RIO_+12V	RIO_-12V	GND
18	NC	LPa_DA+	LPa_DA-	GND	LPa_DC+	LPa_DC-	GND
17	NC	LPa_DB+	LPa_DB-	GND	LPa_DD+	LPa_DD-	GND
16	NC	LPb_DA+	LPb_DA-	GND	LPb_DC+	LPb_DC-	GND
15	NC	LPb_DB+	LPb_DB-	GND	LPb_DD+	LPb_DD-	GND
14	NC	LPa:LINK	LPb:LINK	LPab:CT1	LPc:LINK	RSV (FAN:SEN2)	GND
13	NC	LPa:ACT	LPb:ACT	LPcd:CT1	LPc:ACT	RSV (FAN:SEN1)	GND
12	NC	LPc:DA+	LPc:DA-	GND	LPc:DC+	LPc:DC-	GND
11	NC	LPc:DB+	LPc:DB-	GND	LPc:DD+	LPc:DD-	GND
10	NC	USB1:VCC	USB0:VCC	GND	USB3:VCC	USB2:VCC	GND
9	NC	USB1:D-	USB1:D+	GND	USB3:D-	USB3:D+	GND
8	NC	USB0:D-	USB0:D+	GND	USB2:D-	USB2:D+	GND
7	NC	RIO_3.3V	GPIO	GPI1	GPI2	SPEAKER	GND
6	NC	VGA:RED	VGA:GREEN	VGA:SDA	DEBUG:CLK	DEBUG:DAT	GND
5	NC	VGA:BLUE	VGA:HSYNC	VGA:VSYNC	VGA:SCL	LPd:DC+	GND
4	NC	LPd:DA+	LPd:DA-	SPB:TX-/TX	SPB:TX+/RTS	LPd:DC-	GND
3	NC	LPd:DB+	LPd:DB-	SPB:RX-/CTS	SPB:RX+/RX	LPd:DD+	GND
2	NC	SPA:RI	SPA:DTR	SPA:CTS	SPA:TX	LPd:DD-	GND
1	NC	SPA:RTS	SPA:RX	SPA:DSR	SPA:DCD	RIO_ID1	GND

Table 21: CompactPCI Rear I/O Connector J3 Signals for CP6007-RA

SIGNAL	DESCRIPTION
SPA	COMA signaling (RS-232)
SPB	COMB signaling (RS-422/RS-232)
VGA	Graphic signaling
USB0 to USB3	USB port signaling
SPEAKER	Standard PC speaker
FAN	Fan speed sensing
DEBUG	Debug output
LPa	Rear I/O Link Port A (PICMG 2.16)
LPb	Rear I/O Link Port B (PICMG 2.16)
LPab	Center tap voltage for LPa and LPb
LPc	Rear I/O Link Port C
LPd	Rear I/O Link Port D
LPcd	Center tap voltage for LPc and LPd
GPIO	General purpose digital input/output; 3.3 V only

NOTICE

ON the CP6007-RA, COMA can be used either on the front panel or on the rear I/O. It is not possible to use COMA on the front panel and on the rear I/O simultaneously.

For CP6007-RA, shall not use a standard RIO-module! Use only special RIO module!

Table 22: 64-bit CompactPCI Rear I/O Connector J4 Pinout

PIN	Z	A	B	C	D	E	F
25	NC	PIM:1	PIM:3	GND	PIM:2	PIM:4	GND
24	NC	PIM:5	PIM:7	GND	PIM:6	PIM:8	GND
23	NC	NC	RIO_5V	GND	NC	RIO_3.3V	GND
22	NC	PIM:9	PIM:11	GND	PIM:10	PIM:12	GND
21	NC	PIM:13	PIM:15	GND	PIM:14	PIM:16	GND
20	NC	GND	GND	GND	GND	GND	GND
19	NC	PIM:17	PIM:19	GND	PIM:18	PIM:20	GND
18	NC	PIM:21	PIM:23	GND	PIM:22	PIM:24	GND
17	NC	GND	GND	GND	GND	GND	GND
16	NC	PIM:25	PIM:27	GND	PIM:26	PIM:28	GND
15	NC	PIM:29	PIM:31	GND	PIM:30	PIM:32	GND
14-12	Key Area						
11	NC	PIM:33	PIM:35	GND	PIM:34	PIM:36	GND
10	NC	PIM:37	PIM:39	GND	PIM:38	PIM:40	GND
9	NC	GND	GND	GND	GND	GND	GND
8	NC	PIM:41	PIM:43	GND	PIM:42	PIM:44	GND
7	NC	PIM:45	PIM:47	GND	PIM:46	PIM:48	GND
6	NC	GND	GND	GND	GND	GND	GND
5	NC	PIM:49	PIM:51	GND	PIM:50	PIM:52	GND
4	NC	PIM:53	PIM:55	GND	PIM:54	PIM:56	GND
3	NC	GND	GND	GND	GND	GND	GND
2	NC	PIM:57	PIM:59	GND	PIM:58	PIM:60	GND
1	NC	PIM:61	PIM:63	GND	PIM:62	PIM:64	GND

NOTICE

The signals from the J4 CompactPCI rear I/O connector are routed to the J17 (Jn4) PMC connector in such a way that they can only be used for low-speed signals!

Table 23: CompactPCI Rear I/O Connector J5 Pinout

PIN	Z	A	B	C	D	E	F
22	NC	GPI3	PWM1:OUT	GND	PWM2:OUT	BATT (3.0V)	GND
21	NC	NC	NC	GND	NC	SYS_WP#	GND
20	NC	GPO0	NC	GND	GPO1	NC	GND
19	NC	GND	GND	GND	NC	NC	GND
18	NC	HDMI2:D0+	HDMI2:D0-	GND	GND	GND	GND
17	NC	HDMI2:D2+	HDMI2:D2-	GND	HDMI2:D1+	HDMI2:D1-	GND
16	NC	RSV	HDMI2:HPDET	GND	GPO2	GPO3	GND
15	NC	HDMI2:CLK+	HDMI2:CLK-	GND	HDMI2:SDA	HDMI2:SDC	GND
14	NC	GND	GND	GND	GND	GND	GND
13	NC	HDMI1:D0+	HDMI1:D0-	GND	HDMI1:D1+	HDMI1:D1-	GND
12	NC	HDMI1:D2+	HDMI1:D2-	GND	RSV	RSV	GND
11	NC	RSV	HDMI1:HPDET	GND	HDMI1:SDA	HDMI1:SDC	GND
10	NC	HDMI1:CLK+	HDMI1:CLK-	GND	RSV	RSV	GND
9	NC	GND	GND	GND	GND	GND	GND
8	NC	SATA3:TX+	SATA3:TX-	GND	SATA3:RX+	SATA3:RX-	GND
7	NC	GND	GND	GND	GND	GND	GND
6	NC	SATA2:TX+	SATA2:TX-	GND	SATA2:RX+	SATA2:RX-	GND
5	NC	GND	GND	GND	GND	GND	GND
4	NC	SATA1:TX+	SATA1:TX-	GND	SATA1:RX+	SATA1:RX-	GND
3	NC	GND	GND	GND	GND	GND	GND
2	NC	SATA0:TX+	SATA0:TX-	GND	SATA0:RX+	SATA0:RX-	GND
1	NC	GND	GND	GND	GND	GND	GND

Table 24: CompactPCI Rear I/O Connector J5 Signals

SIGNAL	DESCRIPTION
SATA0...3	SATA Port 0...3 Signaling
HDMI1	HDMI signaling
HDMI2	HDMI signaling
PWM	Pulse width modulation output for fan
GPIO	General purpose digital input/output; 3.3 V only
SYS_WP#	System write protection for non-volatile memory devices; 3.3 V only
BATT (3.0V)	Back-up power input for RTC and CMOS RAM; 3.0 V only

3/ Configuration

3.1. DIP Switch Configuration

The DIP switches SW3 and SW4 are located near the front panel at the bottom side of CP6007.

Figure 8: Location of DIP Switch SW3 and SW4

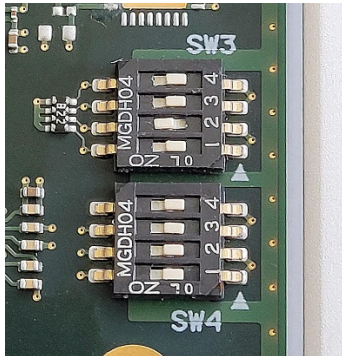

3.1.1. DIP Switch SW3

The DIP switch SW3 serves for general board configuration.

Table 25: DIP Switch SW3 Functionality

SWITCH	SETTING	FUNCTIONALITY
1	OFF	Boot-up with POST code indication on LED3-0
	ON	Boot-up with no POST code indication on LED3-0
2	OFF	Boot from the standard SPI boot flash
	ON	Boot from the recovery SPI boot flash
3	OFF	Non-volatile memory write protection disabled (if no other write protection sources are enabled. Factory and user EPROM only)
	ON	Non-volatile memory write protection enabled
4	OFF	Boot using the currently saved uEFI BIOS settings
	ON	Clear the uEFI BIOS settings and use the default values

The default setting is indicated by using italic bold.

To clear the uEFI BIOS settings and the passwords, proceed as follows:

1. Set DIP switch SW3, switch 4, to the ON position.
2. Apply power to the system.
3. Wait 30 seconds and then remove power from the system. During this time period no messages are displayed. (If power is not turned off, UEFI/BIOS starts with default settings).
4. Set DIP switch SW3, switch 4, to the OFF position.

3.1.2. DIP Switch SW4

The DIP switch SW4 serves for CompactPCI and PMC PCI interface configuration.

Table 26: DIP Switch SW4 Functionality

SWITCH	SETTING	FUNCTIONALITY
1	<i>OFF</i>	CompactPCI frequency 33/66 MHz, auto detection via the backplane
	ON	CompactPCI frequency configured to 33 MHz
2	<i>OFF</i>	CompactPCI mode (PCI/PCI-X) auto detection via the backplane
	ON	CompactPCI interface configured to PCI mode
3	<i>OFF</i>	PMC PCI frequency 33/66 MHz, auto detection via the PMC interface
	ON	PMC PCI frequency configured to 33 MHz
4	<i>OFF</i>	Reserved
	ON	

3.2. System Write Protection

The CP6007 provides write protection for non-volatile memories via the DIP switch SW3, the uEFI Shell and a backplane pin. If one of these sources is enabled, the system is write protected. Please contact Kontron for further information before using these functions.

3.3. CP6007-Specific Registers

Table 27: CP6007-Specific Registers

ADDRESS	DEVICE
0x284	Write Protection Register (WPROT)
0x285	Reset Status Register (RSTAT)
0x288	Board ID High Byte Register (BIDH)
0x28A	Geographic Addressing Register (GEOAD)
0x28C	Watchdog Timer Control Register (WTIM)
0x28D	Board ID Low Byte Register (BIDL)
0x290	LED Configuration Register (LCFG)
0x291	LED Control Register (LCTRL)
0x292	General Purpose Output Register (GPOUT)
0x293	General Purpose Input Register (GPIN)

3.3.1. Write Protection Register (WPROT)

The Write Protection Register holds the write protect signals for non-volatile devices.

Table 28: Write Protection Register (WPROT)

ADDRESS	0x284							
BIT	7	6	5	4	3	2	1	0
NAME	SWP	Reserved			SFWP	DSWP	BSWP	SSWP
ACCESS	R	R			R	R	R	R/W
RESET	0	000			0	0	0	0
BITFIELD		DESCRIPTION						
7	SWP	System write protection status: 0 = Onboard non-volatile memory devices not write protected 1 = Onboard non-volatile memory devices write protected (only user and factory EPROM)						
3 - 6	SFWP	Reserved						
2	DSWP	This bit reflects the state of the system write protection via DIP switch SW3, switch 3: 0 = System not write protected via DIP switch 1 = User, Factory EPROM write protected						
1	BSWP	This bit reflects the state of the system write protection via backplane (SYS_WP#): 0 = System not write protected via backplane 1 = User, Factory EPROM and IPMI write protected						
0	SSWP	N/A						

3.3.2. Reset Status Register (RSTAT)

The Reset Status Register is used to determine the host's reset source.

Table 29: Reset Status Register (RSTAT)

ADDRESS	0x285							
BIT	7	6	5	4	3	2	1	0
NAME	PORS	Reserved	SRST	Reserved	IPRS	FPRS	CPRS	WTRS
ACCESS	R/W	R	R/W	R	R/W	R/W	R/W	R/W
RESET	N/A	0	0	0	0	0	0	0
BITFIELD		DESCRIPTION						
7	PORS	Power-on reset status: 0 = System reset generated by warm reset 1 = System reset generated by power-on (cold) reset Writing a '1' to this bit clears the bit.						
5	SRST	Software reset status: 0 = Reset is logged by the IPMI controller 1 = Reset is not logged by IPMI controller The uEFI BIOS / software sets this bit to inform the IPMI controller that the next reset should not be logged.						
3	IPRS	IPMI controller reset status: 0 = System reset not generated by IPMI 1 = System reset generated by IPMI Writing a '1' to this bit clears the bit.						
2	FPRS	Front panel push button reset status: 0 = System reset not generated by front panel reset 1 = System reset generated by front panel reset Writing a '1' to this bit clears the bit.						
1	CPRS	CompactPCI reset status (PRST signal): 0 = System reset not generated by CompactPCI reset input 1 = System reset generated by CompactPCI reset input Writing a '1' to this bit clears the bit.						
0	WTRS	Watchdog timer reset status: 0 = System reset generated by Watchdog timer 1 = System reset generated by Watchdog timer Writing a '1' to this bit clears the bit.						

NOTICE

The Reset Status Register is set to default values by power-on (cold) reset, not by a warm reset.

3.3.3. Board ID High Byte Register (BIDH)

Table 30: Board ID High Byte Register (BIDH)

ADDRESS	0x288							
BIT	7	6	5	4	3	2	1	0
NAME	BIDH							
ACCESS	R							
RESET	0xB4							
BITFIELD		DESCRIPTION						
7..0	BIDH	Board identification: CP6007-SA: 0xB4C0 CP6007-RA: 0xB4C1						

3.3.4. Geographic Addressing Register (GEOAD)

The Geographic Addressing Register holds the CompactPCI geographic address (slot number) used to assign the Intelligent Platform Management Bus (IPMB) address to the CP6007.

Table 31: Geographic Addressing Register (GEOAD)

ADDRESS	0x28A							
BIT	7	6	5	4	3	2	1	0
NAME	Reserved				GA			
ACCESS	R				R			
RESET	000				N/A			
BITFIELD		DESCRIPTION						
7..5	Res.	Reserved						
4..0	GA	Geographic address						

NOTICE

The Geographic Addressing Register is set to default values by power-on (cold) reset, not by a warm reset.

3.3.5. Watchdog Timer Control Register (WTIM)

Table 32: Watchdog Timer Control Register (WTIM)

ADDRESS	0x28C							
BIT	7	6	5	4	3	2	1	0
NAME	WTE	WMD		WEN/WT R	WTM			
ACCESS	R/W	R/W		R/W	R/W			
RESET	0	00		0	0000			
BITFIELD		DESCRIPTION						
7	WTE	Watchdog timer expired status bit: 0 = Watchdog timer has not expired 1 = Watchdog timer has expired. Writing a '1' to this bit resets it to 0.						
6..5	WMD	Watchdog mode: 00 = Timer only mode 01 = Reset mode 10 = Interrupt mode 11 = Cascaded mode (dual-stage mode)						
4	WEN/WT R	Watchdog enable / Watchdog trigger control bit: 0 = Watchdog timer not enabled Prior to the Watchdog being enabled, this bit is known as WEN. After the Watchdog is enabled, it is known as WTR. Once the Watchdog timer has been enabled, this bit cannot be reset to 0. As long as the Watchdog timer is enabled, it will indicate a '1'. 1 = Watchdog timer enabled Writing a '1' to this bit causes the Watchdog to be retriggered to the timer value indicated by bits WTM[3..0].						
3..0	WTM	Watchdog timeout settings: 0000 = 0.125 s 1000 = 32 s 0001 = 0.25 s 1001 = 64 s 0010 = 0.5 s 1010 = 128 s 0011 = 1 s 1011 = 256 s 0100 = 2 s 1100 = 512 s 0101 = 4 s 1101 = 1024 s 0110 = 8 s 1110 = 2048 s 0111 = 16 s 1111 = 4096 s						

3.3.6. Board ID Low Byte Register (BIDL)

Table 33: Board ID Low Byte Register (BIDL)

ADDRESS	0x28D							
BIT	7	6	5	4	3	2	1	0
NAME	BIDL							
ACCESS	R							
RESET	0xC0 (CP6007-SA) / 0xC1 (CP6007-RA)							
BITFIELD		DESCRIPTION						
7	BIDL	Board identification: CP6007-SA: 0xB4C0 CP6007-RA: 0xB4C1						

3.3.7. LED Configuration Register (LCFG)

The LED Configuration Register holds a series of bits defining the onboard configuration for the front panel General Purpose LEDs.

Table 34: LED Configuration Register (LCFG)

ADDRESS	0x290							
BIT	7	6	5	4	3	2	1	0
NAME	Reserved				LCON			
ACCESS	R				R/W			
RESET	0000				0000			
BITFIELD		DESCRIPTION						
3..0	LCON	LED3–0 configuration: 0000 = POST Mode (LEDs build a binary vector to display Port 80 signals) 0001 = General Purpose Mode (LEDs are controlled via the LCTRL register) 0010 = LEDs are dedicated to functions: ▶ LED1: 10 Gigabit Ethernet controller port 0 link status ▶ LED2: SATA LED 0011-1111 = Reserved						

Beside the configurable functions described above, LED3–0 fulfill also a basic debug function during the power-up phase as long as the first access to Port 80 is processed. For further information on reading the 8-bit uEFI BIOS POST Code, refer to Chapter 2.7.1.3, "General Purpose LEDs".

3.3.8. LED Control Register (LCTRL)

The LED Control Register enables the user to switch on and off the front panel General Purpose LEDs.

Table 35: LED Control Register (LCTRL)

ADDRESS	0x291							
BIT	7	6	5	4	3	2	1	0
NAME	LCMD				LCOL			
ACCESS	R/W				R/W			
RESET	0000				0000			
BITFIELD		DESCRIPTION						
7..4	LCMD	LED command: 0000 = Get LED0 1000 = Set LED0 0001 = Get LED1 1001 = Set LED1 0010 = Get LED2 1010 = Set LED2 0011 = Get LED3 1011 = Set LED3 0100 - 0111 = Reserved 1100 - 1111 = Reserved						
3..0	LCOL	LED color: 0000 = Off 0001 = Green 0010 = Red 0011 = Red+Green 0100 - 1111 = Reserved						

NOTICE

The LED Control Register can only be used if the General Purpose LEDs indicated in the “LED Configuration Register” (see Table 38) are configured in General Purpose Mode.

3.3.9. General Purpose Output Register (GPOUT)

The General Purpose Output Register holds the general purpose output signals of the rear I/O CompactPCI connectors.

Table 36: General Purpose Output Register (GPOUT)

ADDRESS	0x292							
BIT	7	6	5	4	3	2	1	0
NAME	Reserved				GPO3	GPO2	GPO1	GPO0
ACCESS	R				R/W	R/W	R/W	R/W
RESET	0000				0	0	0	00
BITFIELD		DESCRIPTION						
3..0	GPO3..0	General purpose output signals: 0 = Output low 1 = Output high						

3.3.10. General Purpose Input Register (GPIN)

The General Purpose Input Register holds the general purpose input signals of the rear I/O CompactPCI connectors.

Table 37: General Purpose Input Register (GPIN)

ADDRESS	0x293							
BIT	7	6	5	4	3	2	1	0
NAME	Reserved				GPI3	GPI2	GPI1	GPI0
ACCESS	R				R	R	R	R
RESET	0000				1	1	1	1
BITFIELD		DESCRIPTION						
3..0	GPI3..0	General purpose input signals: 0 = Input low 1 = Input high						

4/ Power Considerations

4.1. System Power

The considerations presented in the chapters below must be taken into account by system integrators when specifying the CP6007 system environment.

4.1.1. CP6007 Voltage Ranges

The CP6007 has been designed for optimal power input and distribution. Still it is necessary to observe certain criteria essential for application stability and reliability.

The system power supply must comply with the CompactPCI® specification.

The following table specifies the ranges for the input power voltage within which the board is functional.

Table 38: Operational Input Voltage Range

INPUT SUPPLY VOLTAGE	ABSOLUTE RANGE
+3.3 V	3.2 V min. to 3.47 V max.
+5 V	4.85 V min. to 5.25 V max.
+12 V	11.4 V min. to 12.6 V max.
-12 V	-11.4 V min. to -12.6 V max.

NOTICE

Failure to comply with the instructions above may result in damage to the board or improper operation.

4.1.2. Power Supply Units

Power supplies for the CP6007 must be specified with enough reserve for the remaining system consumption. In order to guarantee a stable functionality of the system, it is recommended to provide more power than the system requires. An industrial power supply unit should be able to provide at least twice as much power as the entire system requires.

As the design of the CP6007 has been optimized for minimal power consumption, the power supply unit shall be stable even without minimum load.

Where possible, power supplies which support voltage sensing should be used. Depending on the system configuration this may require an appropriate backplane. The power supply should be sufficient to allow for backplane input line resistance variations due to temperature changes, etc.

WARNING

The maximum permitted power of the "CPCI board" indicated in the tables above and below (XMX and PMC power) must not be exceeded. Failure to comply with the above may result in damage to your board (See also General Safety Instructions for IT Equipment).

4.1.2.1. Start-Up Requirement

Power supplies must comply with the following guidelines, in order to be used with the CP6007:

- ▶ Beginning at 10% of the nominal output voltage, the voltage must rise within $> 0.1 \text{ ms}$ to $< 20 \text{ ms}$ to the specified regulation range of the voltage. Typically: $> 5 \text{ ms}$ to $< 15 \text{ ms}$.
- ▶ There must be a smooth and continuous ramp of each DC output voltage from 10% to 90% of the regulation band.
- ▶ The slope of the turn-on waveform shall be a positive, almost linear voltage increase and have a value from 0 V to nominal V_{out} .

4.1.2.2. Power-Up Sequence

The +5 VDC output level must always be equal to or higher than the +3.3 VDC output during power-up and normal operation.

Both voltages must reach their minimum in-regulation level not later than 20 ms after the output power ramp start.

4.1.2.3. Regulation

The power supply shall be unconditionally stable under line, load, unload and transient load conditions including capacitive loads. The operation of the power supply must be consistent even without the minimum load on all output lines.

NOTICE

All of the input voltages must be functionally coupled to each other so that if one input voltage fails, all other input voltages must be regulated proportionately to the failed voltage. For example, if the +5V begins to decrease, all other input voltages must decrease accordingly. This is required in order to preclude cross currents within the CP6007. Failure to comply with above may result in damage to the board or improper system operation.

NOTICE

If the main power input is switched off, the supply voltages will not go to 0V instantly. It will take a couple of seconds until the capacitors are discharged. If the voltage rises again before it has gone below a certain level, the circuits may enter a latch-up state where even a hard RESET will not help any more. The system must be switched off for at least 10 seconds before it may be switched on again. If problems still occur, turn off the main power for 30 seconds before turning it on again.

4.2. Power Consumption

The goal of this description is to provide a method to calculate the power consumption for the CP6007-SA or CP6007-RA baseboard and for additional configurations. The processor and the memory dissipate the majority of the thermal power.

The power consumption measurements were carried out using the following testing parameters:

- ▶ CP6007-SA or CP6007-RA installed in the system slot
- ▶ Ethernet ports not connected
- ▶ CP6007-SA: 32GB memory down + 32GB SO-DIMM; CP6007-RA: 32GB memory down
- ▶ +3.3 V, +5 V, +12 V and -12 V main supply voltage
- ▶ 2.5 m/s airflow

The operating systems used were uEFI Shell and Windows® 10 Pro, 64-bit. All measurements were conducted at an ambient temperature of 25 °C. The power consumption values indicated in the tables below can vary depending on the ambient temperature. This can result in deviations of the power consumption values of up to 15%.

The power consumption was measured using the following platforms:

- ▶ CP6007-SA: Intel® XEON®-W-11865MRE, 2GHz
- ▶ CP6007-RA: Intel® Xeon®-W-11555MRE, 2GHz

The power consumption was measured using the following configurations:

- ▶ Work load: uEFI Shell
For this measurement the processor cores were active, the graphics controller was in idle state (no application running) and Intel® Turbo Boost Technology was disabled.
- ▶ Work load: Idle (Win 10 Pro)
For this measurement all processor cores were in idle state (no application running) and Intel® Turbo Boost Technology was disabled.
- ▶ Work load: Typical (Intel PTAT)
For this measurement all processor cores were operating at 70% work load while Intel® Turbo Boost Technology was disabled. These values represent the power dissipation reached under realistic, OS-controlled applications.
- ▶ Work load: Maximum (Intel PTAT Tool)
These values represent the maximum power dissipation achieved through the use of specific tools to heat up the processor cores. For this measurement Intel® Turbo Boost Technology was disabled. These values are unlikely to be reached in real applications (all cores were operating at 100%).

NOTICE

To support the extended temperature range (+70°C), the maximum power consumption of the processors must be reduced. The maximum power consumption of the Intel® Xeon® W-11865MRE and Intel® Xeon® W-11555MRE processors can be reduced using the Power Limit Reduction feature (cTDP). This feature can be configured via the kBoardConfig uEFI Shell command. For information on this command, refer to the Chapter 9, uEFI BIOS.

Table 39: Workload: uEFI Shell

NOMINAL VOLTAGE	CP6007-SA XEON® W-11865MRE, 2GHz	CP6007-RA XEON® W-11555MRE, 2GHz
+12 V	0.1 W	0.1 W
5 V	19.8 W	17.5 W
3.3 V	5.6 W	5.5 W
Total	25.5 W	23.1 W

Table 40: Workload: Idle (Win 7)

NOMINAL VOLTAGE	CP6007-SA XEON® W-11865MRE, 2GHz	CP6007-RA XEON® W-11555MRE, 2GHz
+12 V	0.1 W	0.1 W
5 V	19.7 W	15.9 W
3.3 V	6.3 W	5.5 W
Total	26.1 W	21.5 W

Table 41: Workload: Typical

NOMINAL VOLTAGE	CP6007-SA XEON® W-11865MRE, 2GHz	CP6007-RA XEON® W-11555MRE, 2GHz
+12 V	0.1 W	0.1 W
5 V	38.5 W	29.6 W
3.3 V	6.4 W	6.2 W
Total	45 W	35.9 W

Table 42: Workload: Maximum

NOMINAL VOLTAGE	CP6007-SA XEON® W-11865MRE, 2GHz	CP6007-RA XEON® W-11555MRE, 2GHz
+12 V	0.1 W	0.1 W
5 V	44.3 W	34.6 W
3.3 V	6.4 W	6.2 W
Total	50.8 W	40.9 W

4.2.1. Power Consumption of the CP6007-SA Accessories

The following table indicates the power consumption of the CP6007-SA accessories.

Table 43: Power Consumption of CP6007-SA Accessories

POWER CONSUMPTION	POWER 5 V	POWER 3.3 V
DDR4 32GB SO-DIMM	approx. 7.5 W	-

4.2.2. Power Consumption per Gigabit Ethernet Port

The following table indicates the power consumption per Gigabit Ethernet port.

Table 44: Power Consumption per Gigabit Ethernet Port

POWER CONSUMPTION	POWER 5 V	POWER 3.3 V
One 1000 Mb/s Ethernet port connected	—	approx. 0.5 W

4.2.3. Power Consumption of PMC Modules

A maximum power of 7.5 W is available on the PMC slot. This is in accordance with the draft standard P1386/Draft 2.4a. The maximum power of 7.5 W can be arbitrarily divided on the 3.3 V and 5 V voltage lines.

The following table indicates the available current of a PMC module.

Table 45: PMC Module Current

VOLTAGE	CONTINUOUS CURRENT	PEAK CURRENT
3.3 V	2.27 A	3.0 A
5 V	1.5 A	2.0 A
+12 V	0.6 A	0.8 A
-12 V	0.4 A	0.4 A

4.2.4. Power Consumption of XMC Modules

A maximum power of 20 W is available on the XMC slot and it can be arbitrarily divided on the 3.3 V and 5 V (VPWR) voltage lines. XMC modules are based on 3.3 V power along with variable power (VPWR) defined as either 5 V or 12 V in the ANSI/VITA 42.0-200x XMC Switched Mezzanine Card Auxiliary Standard specification. On the CP6007-SA, the VPWR is configured to 5 V.

The following table indicates the available current of an XMC module.

Table 46: XMC Module Current

VOLTAGE	CONTINUOUS CURRENT	PEAK CURRENT
3.3 V	1.0 A	1.25 A
5 V (VPWR)	3.0 A	3.5 A
+12 V	0.6 A	0.8 A
-12 V	0.4 A	0.4 A

NOTICE

XMC integrators should carefully review the power ratings, cooling capacity and airflow requirements in the application prior to installation of an XMC module on the CP6007-SA.

5/ Thermal Considerations

The thermal characteristic graphs shown in the following sections are intended to serve as guidance for reconciling the required computing power with the necessary system volumetric airflow over the ambient temperature. The graphs contain two curves representing upper level working points based on different levels of average CPU utilization. When operating below the corresponding curve, the CPU runs without any intervention of thermal supervision (all processors have a T_{JUNCTION} from 100°C). When operated above the corresponding curve, various thermal protection mechanisms may take effect resulting in temporarily reduced CPU performance or finally in an emergency stop (the CPU is at 130°C) in order to protect the CPU from thermal destruction (in this case the power must be switched off and then on again). In real applications this means that the board can be operated temporarily at a higher ambient temperature or at a reduced flow rate and still provide some margin for temporarily requested peak performance before thermal protection will be activated.

An airflow of 2.0 m/s to 3.0 m/s or a volumetric flow rate of 15 CFM to 20 CFM is a typical value for a standard Kontron ASM rack. For other racks or housings the available airflow will differ. The maximum ambient operating temperature must be determined for such environments.

5.1. How to read the Temperature Diagrams

Select a specific CPU and choose a specific working point. For a given flow rate there is a maximum airflow input temperature (= ambient temperature) provided. Below this operating point, thermal supervision will not be activated. Above this operating point, thermal supervision will become active protecting the CPU from thermal destruction. The minimum airflow rate provided must be more than the value specified in the diagram.

5.2. Volumetric flow rate

The volumetric flow rate refers to an airflow through a fixed cross-sectional area (i.e. slot width x depth). The volumetric flow rate is specified in m^3/h (cubic-meter-per-hour) or cfm (cubic-feet-per-minute) respectively.

Conversion: 1 cfm = 1.7 m^3/h ; 1 m^3/h = 0.59 cfm

5.3. Airflow

At a given cross-sectional area and a required flow rate, an average, homogeneous airflow speed can be calculated using the following formula:

Airflow = Volumetric flow rate / area.

The airflow is specified in m/s (meter-per-second) or in fps (feet-per-second) respectively.

Conversion: 1 fps = 0.3048 m/s; 1 m/s = 3.28 fps

The following figures illustrate the thermal operational limits of the CP6007-SA taking into consideration power consumption vs. ambient air temperature vs. airflow rate.

NOTICE

The CP6007-SA must be operated within the thermal operational limits indicated below.

Figure 9: Ambient Temperature for Xeon® W-11865MRE, measured by Intel PTU Tool for Broadwell-DE rev. 1.1

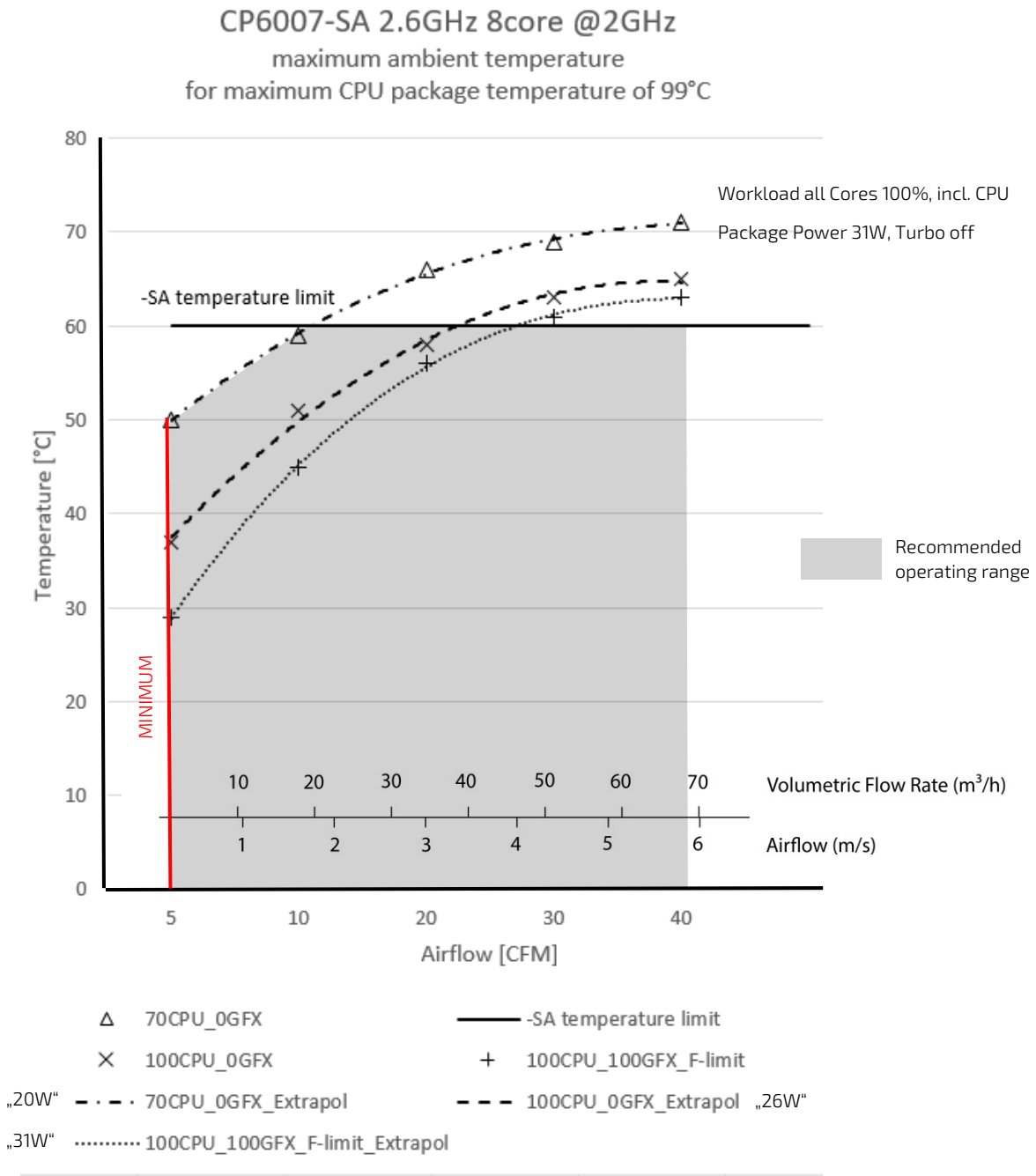
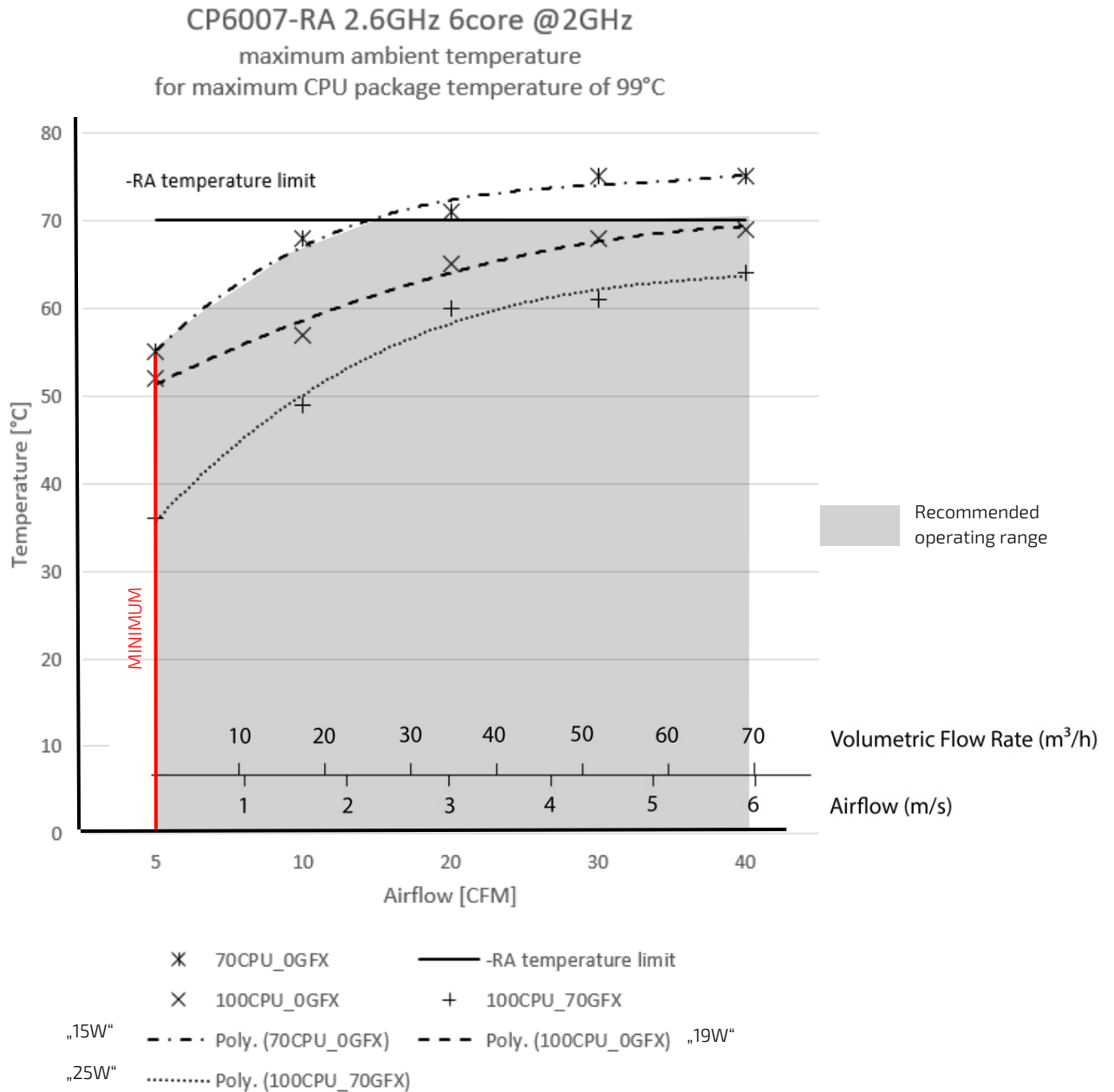

Figure 10: Ambient Temperature for Xeon® W-11555MRE, measured by Intel PTU Tool for Broadwell-DE rev. 1.1



5.3.1. Peripherals

When determining the thermal requirements for a given application, peripherals to be used with the CP6007-SA must also be considered. Devices such as HDDs, SSDs, PMC modules, XMC modules which are directly attached to the CP6007-SA must also be capable of being operated at the temperatures foreseen for the application. It may very well be necessary to revise system requirements to comply with operational environment conditions. In most cases, this will lead to a reduction in the maximum allowable ambient operating temperature or even require active cooling of the operating environment.

NOTICE

As Kontron assumes no responsibility for any damage to the CP6007-SA or other equipment resulting from overheating of the CPU, it is highly recommended that system integrators as well as end users confirm that the operational environment of the CP6007-SA complies with the thermal considerations set forth in this document.

6/ Installation

This chapter is oriented towards an application environment. Some aspects may, however, be applicable to a development environment.

6.1. Safety

To ensure personnel safety and correct operation of this product, the following safety precautions must be observed:

- ▶ All operations involving the CP6007 require that personnel be familiar with system equipment, safety requirements and the CP6007.
- ▶ This product contains electrostatically sensitive components which can be seriously damaged by electrical static discharge (ESD). Therefore, proper handling must be ensured at all times.
- ▶ Whenever possible, unpack or pack this product only at EOS/ESD safe work stations. Where a safe work station is not guaranteed, it is important for the user to be electrically discharged before touching the product with his/her hands or tools. This is most easily done by touching a metal part of your system housing.
- ▶ Do not handle this product out of its protective enclosure while it is not used for operational purposes unless it is otherwise protected.
- ▶ Do not touch components, connector-pins or traces.

Kontron assumes no liability for any damage resulting from failure to comply with these requirements.

6.2. General Instructions on Usage

In order to maintain Kontron's product warranty, this product must not be altered or modified in any way. Changes or modifications to the device, which are not explicitly approved by Kontron and described in this manual or received from Kontron's Technical Support as a special handling instruction, will void your warranty.

This device should only be installed in or connected to systems that fulfill all necessary technical and specific environmental requirements. This applies also to the operational temperature range of the specific board version, which must not be exceeded. If batteries are present, their temperature restrictions must be taken into account.

6.3. Board Installation

The CP6007 is designed for use either as a system board or as an autonomous CPU board in a peripheral slot.

When installed in the system slot, the CP6007 provides all required functions for supporting the hot swapping of peripheral boards which are capable of being hot swapped.

When installed in a peripheral slot, the CP6007 operates autonomously, meaning that it only draws power from the backplane.

6.3.1. Hot Swap Insertion

Prior to following the steps below, ensure that the safety requirements are met.

To insert the CP6007 in a running system proceed as follows:

1. Ensure that the board ejection handles are open.
2. Insert the board into the slot designated until it makes contact with the backplane connectors.
3. Using the ejector handles, engage the board with the backplane. When the ejector handles are closed, the board is engaged.
4. The blue HS LED turns on and then off indicating that the CP6007 is operating.
5. Fasten the front panel retaining screws.
6. Connect all external interfacing cables to the board as required.

6.3.2. Hot Swap Removal

Prior to following the steps below, ensure that the safety requirements are met. When removing a board from the system, particular attention must be paid to the components that may be hot, such as heat sink, etc.

To remove the CP6007 from a running system proceed as follows:

1. Unlock the board ejection handles by pressing their release buttons.
The blue HS LED starts blinking indicating that the shutdown process has begun.
2. After approximately 1 to 15 seconds, the HS LED turns on steady indicating that the CP6007 may be removed from the system.
3. Disconnect any interfacing cables that may be connected to the board.
4. Unscrew the front panel retaining screws.
5. Using the ejector handles, disengage the board from the backplane and remove it from the system.

6.4. Installation of Peripheral Devices

The CP6007 is designed to accommodate various peripheral devices, such as M.2 (SATA), PMC, XMC, and rear I/O devices.

Prior to installation of a peripheral device, ensure that the safety requirements are met. Special attention must be paid to avoid touching any components that may be hot, such as heat sink, etc.

Figure 11: CP6007-SA with M.2 card and heat sink installed

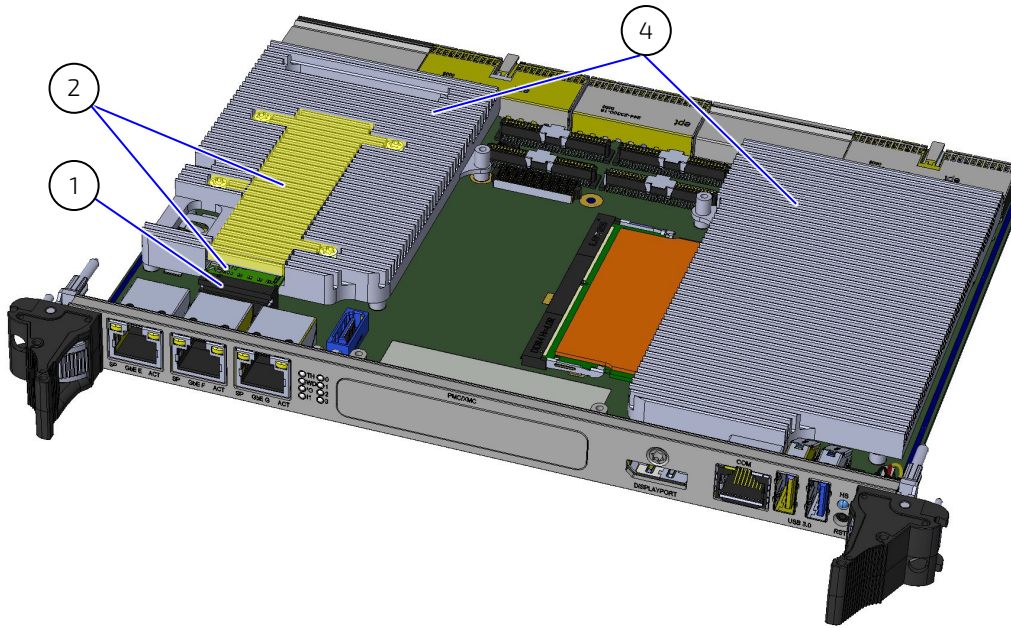
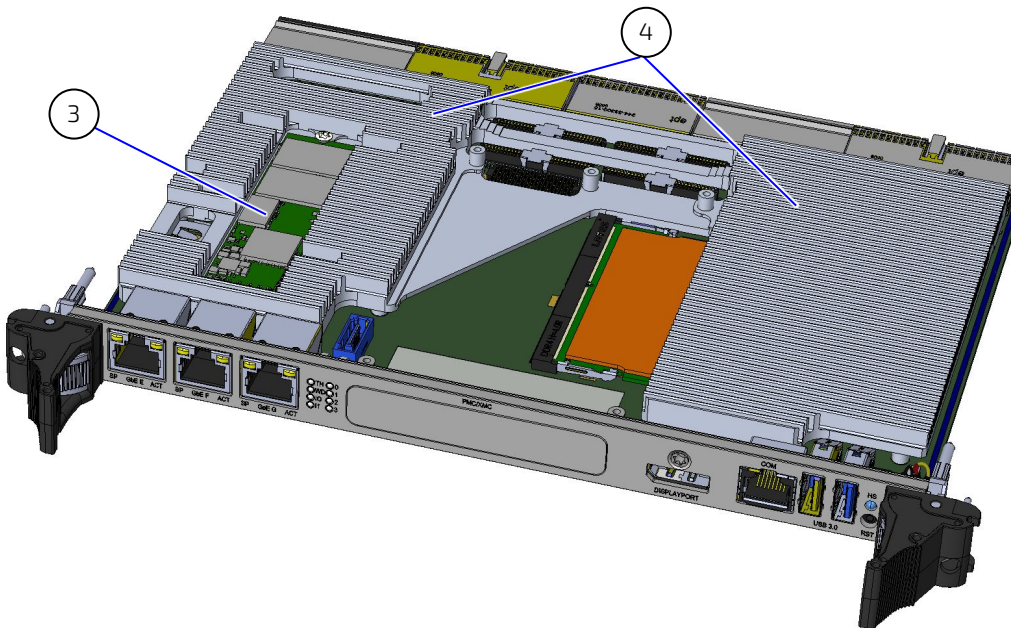

Figure 12: CP6007-RA with M.2 card installed, without heat sink



- | | |
|---|-----------------------------------|
| 1. M.2 Connector | 3. M.2 Module (without heat sink) |
| 2. M.2 Module (with heat sink, marked yellow) | 4. CP6007 Heat Sink |

6.4.1. SATA M.2 Module Installation

A SATA Flash module may be connected to the CP6007 via the onboard connector, J18. This optionally available module must be physically installed on the CP6007 prior to installation of the CP6007 in a system. During installation it is necessary to ensure that the SATA Flash module is properly seated in the onboard connector J18, i.e. the pins are aligned correctly and not bent.

- ▶ SATA device fail message at boot-up: may be a bad cable or lack of power going to the drive
- ▶ SATA device fail message at boot-up on Rear I/O module, caused by forced speed to 6.0Gb/s (see Chapter 2.7.6 "SATA Interfaces")

NOTICE

The CP6007 does not support removal and reinsertion of the M.2 storage card while the board is in a powered-up state. Connecting the M.2 card while the power is on, which is known as "hot plugging", may damage your system.

NOTICE

The CP6007 supports only single-sided M.2 modules. The heat sink for the M.2 module is provided with the CP6007.

6.4.1.1. Installing a M.2 Card

To install a M.2 card:

1. Remove the 4x mounting screws and then remove the M.2 heat sink from the CP6007.
2. Align the connector on the M.2 card with the connector on the board. Make sure the slits are aligned with the protrusions on the connector.
3. Insert the M.2 card into the connector on the CP6007 board.
4. Secure the M.2 card with the screw (provided with the CP6007).
5. Re-install the M.2 heat sink removed in step 1.

Figure 13: Installing a M.2 Card

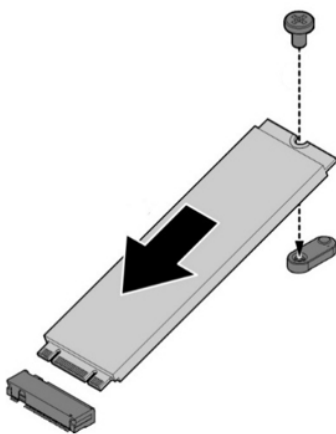

6.4.1.2. Removing a M.2 Card

To remove a M.2 card:

1. Power off the board, and then detach the power cord from the power supply.
2. Remove the CP6007 board.
3. Remove the 4x mounting screws and then remove the M.2 heat sink from the CP6007
4. Remove the screw securing the M.2 card.
5. The M.2 card pops up. Grasp it by the edges and slide it out.

Figure 14: Removing a M.2 Card

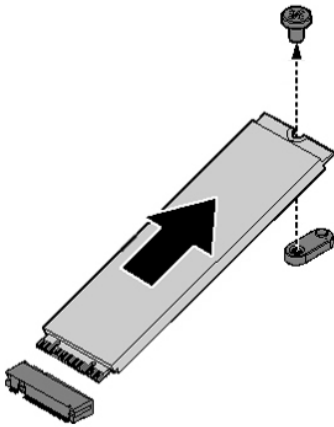

6.4.2. Installation of External SATA Devices

The following information pertains to external SATA devices which may be connected to the CP6007 via normal cabling.

Some symptoms of incorrectly installed SATA devices are:

- ▶ Device on a SATA channel does not spin up: check power cables and cabling. May also result from a bad power supply or SATA device.
The SATA connector on the CP6007 provides only a data connection. The power for this device must be supplied by a separate connector. For further information, refer to the respective documentation of the device.
- ▶ SATA device fail message at boot-up: may be a bad cable or lack of power going to the drive.

6.4.3. PMC Module Installation

The CP6007 supports the installation of a PMC module via the J21 to J22 connectors. For information on the installation of the PMC module, refer to the documentation provided with the module.

Figure 15: CP6007-SA with PMC/XMC Module installed (marked red)

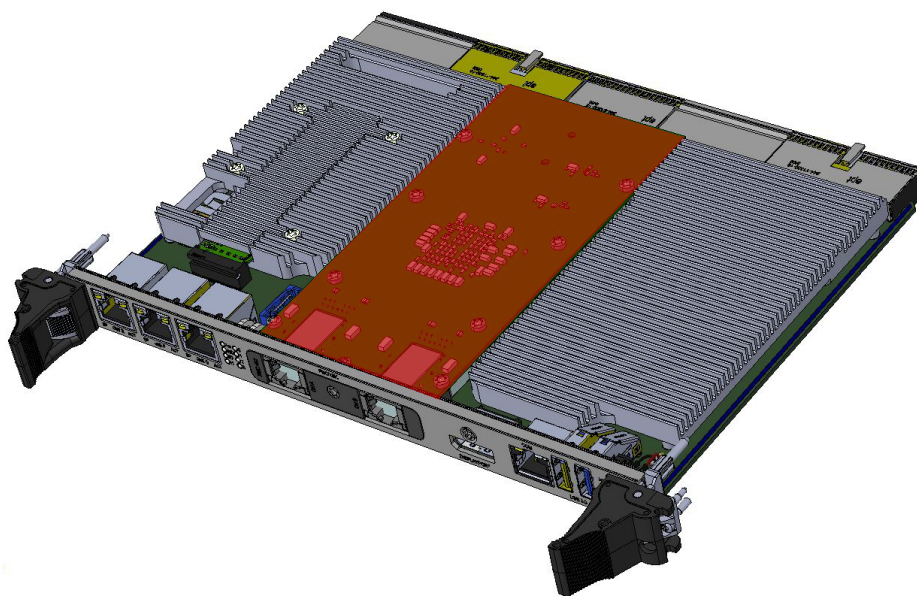

6.4.4. XMC Module Installation

The CP6007 supports the installation of an XMC module via the J20 connector. For information on the installation of the XMC module, refer to the documentation provided with the module.

6.4.5. Rear Transition Module Installation

For physical installation of rear transition modules, refer to the documentation provided with the module itself.

6.5. Battery Replacement

The CP6007 RTC may be backed up using a single UL-approved CR2025, 3.0 V "coin cell" lithium battery from one of two possible points of installation:

- ▶ onboard
- ▶ on the rear transition module

Only one battery may be installed at a time. Refer to Table 1 for battery requirements.

7/ uEFI BIOS

7.1. Starting the uEFI BIOS

The CP6007 is provided with a Kontron-customized, pre-installed and configured version of AMI Aptio V® uEFI BIOS (referred to as uEFI BIOS in this manual). AMI BIOS firmware is based on the unified Extensible Firmware Interface (uEFI) specification and the Intel® Platform Innovation Framework for EFI. This uEFI BIOS provides a variety of new and enhanced functions specifically tailored to the hardware features of the CP6007.

The uEFI BIOS comes with a setup program which provides quick and easy access to the individual function settings for control or modification of the uEFI BIOS configuration. The setup program allows the accessing of various menus which provide functions or access to sub-menus with more specific functions of their own.

To start the uEFI BIOS setup program, follow the steps below:

1. Power on the board.
2. Wait until the first characters appear on the screen (POST messages or splash screen).
3. Press the <F2> or the key.
4. If the uEFI BIOS is password-protected, a request for password will appear.
Enter either the user password or the supervisor password (see Security menu), press <RETURN>, and proceed with step 5.
5. A setup menu will appear.

The CP6007 uEFI BIOS setup program uses a hot key-based navigation system. A hot key legend bar is located on the bottom of the setup screens. The following table provides information concerning the usage of these hot keys.

Table 47: Navigation Hot Keys Available in the Legend Bar

Sub-screen	Description
<F1>	The <F1> key is used to invoke the General Help window.
<F2>	The <F2> key is used to restore previous values.
<F3>	The <F3> key is used to load the standard default values.
<F4>	The <F4> key is used to save the current settings and exit the uEFI BIOS Setup.
<->	The <Minus> key is used to select the next lower value within a field.
<+>	The <Plus> key is used to select the next higher value within a field.
<←> or <→>	The <Left/Right> keys are used to select major setup menus on the menu bar. For example: Main screen, Advanced screen, Security screen, etc.
<↑> or <↓>	The <Up/Down> keys are used to select fields in current menu, for example a setup function or a sub-screen.
<ESC>	The <ESC> key is used to exit a major Setup menu and enter the Exit Setup menu. Pressing the <ESC> key in a sub-menu causes the next higher menu level to be displayed. Changed settings remain changed.
<RETURN>	The <RETURN> key is used to execute a command or select a submenu.

7.2. Setup Menus

The Setup utility features five menus listed in the selection bar at the top of the screen:

- ▶ Main
- ▶ Advanced
- ▶ Security
- ▶ Boot
- ▶ Save & Exit

The Setup menu items are selectable via the <Left/Right> keys. The currently active menu and the currently active Setup item highlighted in white.

Each Setup menu provides two main frames. The left frame displays all available parameters. Parameters that can be configured are displayed in blue. Parameters displayed in gray provide information about the status or the operational configuration. The right frame displays an item-specific help window providing an explanation of the respective parameter.

NOTE: The Setup menu items required for normal operation and configuration are accessible by default.

To have access to all Setup menu items the uEFI BIOS ExpertMode must be activated. I.e. the Setup menu for *Chipset* and various Setup sub menus not accessible by default.

NOTICE

Incorrect uEFI BIOS settings may cause the system to malfunction or even hardware damage.

Changing setup settings, especially those of the Expert Mode are absolutely at your own risk. Do not change these settings unless you really know what you are doing.

7.2.1. Main Setup Menu

Upon entering the uEFI BIOS Setup program, the Setup *Main* menu is displayed. This screen lists the Setup *Main* menu sub-screens and provides basic system information as well as functions for setting the system time and date.

Table 48: Main Setup Menu Functions

FUNCTION	DESCRIPTION
BIOS Information like Version, Build Time, etc.	Read-only fields. Displays information about the system BIOS, processor, memory, etc.
System Date and Time	Show and Set System Date and Time.

7.2.2. Advanced Setup Menu

The Setup *Advanced* menu provides sub-screens and functions for advanced configuration.

NOTICE

Setting items on this screen to incorrect values may cause the system to malfunction.

Table 49: Advanced Setup Menu Sub-Screens and Functions

FUNCTION	DESCRIPTION
Trusted Computing	Configure TPM Device.
ACPI Settings	Configure ACPI (Advanced Configuration and Power Interface) settings.
SMART Settings	Configure SMART (Self-Monitoring, Analysis and Reporting Technology) settings.
Serial Port Console Redirection	Enables/Disables console redirection over serial port.
AMI Graphic Output Protocol Policy	Select Monitor Output by Graphic Output Protocol.
PCI Subsystem Settings	Configure Boards PCI device handling options.
USB Configuration	Configure Boards USB Controllers and USB device handling options.
Network Stack Configuration	Enables/Disables UEFI Network Stack per Network device.
USB Configuration	Configure Boards USB Controllers and USB device handling options.
NVMe Configuration	Display information of connected NCM (Nonvolatile Memory Express) devices
Board UART Configuration	Configure Board's Serial Ports (COM A, COM B).
Board Configuration and I/O Routing	Configure Boards' COM B mode (RS232 or RS422) and Graphic port mode and routing.
Tls Auth Configuration	Handle TLS (Transport Layer Security) certificates.
Intel(R) I350 Gigabit Network Connection(s)	Configure Intel(R) I350 specific Network driver and display device information.
Intel(R) I210 Gigabit Network Connection(s)	Configure Intel(R) I210 Network driver and display device information.
Intel(R) Ethernet Connection I219-LM	Configure Intel(R) I219 Network driver and display device information.
Driver Health	Display Network driver status information

7.2.3. Security Setup Menu

The Setup *Security* menu provides information about the passwords and functions for specifying the security settings. The passwords are case-sensitive. The CP6007 provides no factory-set passwords.

Table 50: Security Setup Menu Functions

FUNCTION	DESCRIPTION
Password Description	Read-only field. Information on Administrator and User Password and password length requirements.
Administrator Password	Create a new or change current administrator password.
User Password	Create a new or change current user password.
HDD Security	Configure SATA / NVMe device passwords. Note: If no SATA / NVMe device is connected, this Setup item is not shown.
Secure Boot menu	Enables/Disables Secure Boot and key management.

NOTICE

If there is already a password installed, the system asks for this first. To clear a password, simply enter nothing and acknowledge by pressing <RETURN>. To set a password, enter it twice and acknowledge by pressing <RETURN>.

7.2.3.1. Remember the Password

It is highly recommended to keep a record of all passwords in a safe place. Forgotten passwords may lead to being completely locked out of the system.

If the system cannot be booted because neither the user password nor the supervisor password are known, refer to the chapter 3.1, for information about clearing the uEFI BIOS settings, or contact Kontron for further assistance.

7.2.4. Boot Setup Menu

The Setup *Boot* menu lists the for boot device priority order, which is dynamically generated.

Table 51: Boot Priority Order

FUNCTION		DESCRIPTION
Boot configuration	Setup Prompt Timeout	Configures number of seconds to wait for setup activation key.
	Bootup NumLock State	Select the keyboard's NumLock state.
	Quiet Boot	Enables/Disables Quiet Boot option
	Fast Boot	Enables/Disables Fast Boot option(S)
Fixed Boot Order Priority	1. Hard Disk	Keys used to view or configure boot devices: <ul style="list-style-type: none"> ▶ <↑> and <↓> keys navigate through boot option devices ▶ <+> and <-> move the device up or down inside Boot Options. ▶ <Enter> select a Boot Option for configuration.
	2. NVME	
	3. UEFI AP: Built-in EFI Shell	
	4. CD/DVD	
	5. SD	
	6. USB Hard Disk	
	7. USB CD/DVD	
	8. USB Key	
	9. USB Floppy	
	10. USB Lan	
	11. Network	
UEFI NVME Drive BBS Priorities		Select boot priority if multiple devices connected
UEFI Application Boot Priorities		Select or disable/enable (built-in or external) EFI Shell
UEFI USB Hard Disk BBS Priorities		Select boot priority if multiple devices connected

Note: List of Setup items depends on connected boot device types.

7.2.5. Exit Setup Menu

The Setup *Exit* menu provides functions for handling changes made to the uEFI BIOS settings and the exiting of the setup program.

Table 52: Exit Setup Menu Functions

FUNCTION		DESCRIPTION
Save Options	Save Changes and Exit	Equal to <F4>. Exit system setup after saving the changes.
	Discard Changes and Exit	Exit system setup without saving any changes.
	Save Changes and Reset	Reset the system after saving the changes.
	Discard Changes and Reset	Reset the system without saving any changes.
	Save Changes	Save all changes of all menus, but do not reset system.
	Discard Changes	Discard Changes done so far to any of the setup options.
Default Options	Restore Defaults	Equal to <F3>. Restore/Load default values for all the setup options.
	Save as User Defaults	Save the changes done so far as User Defaults.
	Restore User Defaults	Restore the User Defaults to all the setup options.
Boot Override	UEFI Built-in EFI Shell	Boot directly to built-in EFI Shell.
	*other 'known' boot devices	*List of 'known' boot devices.

7.3. The uEFI Shell

The Kontron uEFI BIOS features a built-in and enhanced version of the uEFI Shell.

For a detailed description of the available standard shell scripting refer to the EFI Shell user guide. For a detailed description of the available standard shell commands, refer to the EFI Shell command manual. Both documents are available on the EFI and Framework Open Source Community homepage (<http://sourceforge.net/projects/efi-shell/files/documents/>).

Please note that not all shell commands described in the EFI Shell Command manual are provided by the Kontron uEFI BIOS.

The uEFI Shell commands are not case-sensitive. Each uEFI Shell command is provided with a detailed online help that can be invoked by entering "<cmd> <space> <-?>" in the command line. To display the uEFI Shell command list, enter <help> or <?> in the command line.

7.3.1. Introduction, Basic Operation

The uEFI Shell forms an entry into the uEFI boot order and is the first boot option by default.

7.3.1.1. Entering the uEFI Shell

To enter the uEFI Shell, follow the steps below (with uEFI Shell as first boot option):

1. Power on the board.
2. Ignore the message: "Press or <F2> key".
3. If you don't want a startup script to be executed, press the ESC key within 5 seconds after a message such as the one below appears:

```
UEFI Interactive Shell v2.2 with Kontron Extensions
EDK II
UEFI v2.70 (American Megatrends, 0x00050013)
Mapping table
  FS0: Alias(s):HD0r0b:;BLK1:
        PciRoot(0x0)/Pci(0x14,0x0)/USB(0x11,0x0)/HD(1,GPT,4E5B7B98-... ,0x800,0x100000)
  BLK0: Alias(s):
        PciRoot(0x0)/Pci(0x14,0x0)/USB(0x11,0x0)
...
Press the ESC key within 5 seconds to skip startup.nsh, and any other key to continue.
```

The output produced by the device mapping table can vary depending on the board's configuration.

If the ESC key is pressed before the 5-second timeout has elapsed, the shell prompt is shown:

```
Shell>
```

7.3.1.2. Exiting the uEFI Shell

To exit the uEFI Shell, follow one of the steps below:

1. Invoke the **exit** uEFI Shell command to select the boot device in the boot menu for the OS to boot from.
2. Reset the board using the **reset** uEFI Shell command.

7.3.2. Kontron-Specific uEFI Shell Commands

The Kontron uEFI BIOS provides the following additional uEFI Shell commands related to the specific HW features of the Kontron board.

Table 53: Kontron-Specific uEFI Shell Commands

FUNCTION	DESCRIPTION
kBoardConfig	Configures non-volatile board settings, such as: <ul style="list-style-type: none"> ▶ ExpertMode ▶ Update Mode ▶ Pxe ▶ PrimaryDisplay ▶ SataMode ▶ SataSpeed ▶ Sata4HotplugMode ▶ Sata5HotplugMode ▶ Sata6HotplugMode ▶ Sata7HotplugMode ▶ IntelVT ▶ IntelHT ▶ SpeedStep ▶ CpuTurbo ▶ cTDP ▶ ComBMode ▶ ShellTimeOut
kBoardInfo	Shows a summary of board-specific data like serial numbers, board/hw/cpu/chipset revisions. It also displays/checks parameters such as the current uEFI BIOS revision, for scripting.
kboot	If the requested device is not present, boot returns to shell. If a requested device is present but not bootable, uEFI continues to boot with the next bootable device in the boot order.
kBootNsh	Manages the flash-stored startup script (boot.nsh) If the shell is launched by the boot process, it executes a shell script stored in the flash. If the shell script terminates, the shell will continue the boot process. However, the shell script can also contain any other boot command.
klpmi	Executes a comprehensive set of IPMI functions from the uEFI Shell using the KCS interface and manages also IPMI firmware upgrade.
kMkRamdisk	Make and manage RAM-disks This command is used to perform file operations when no real file system is connected, and is required for handling startup script, refer to <i>kBootNsh</i> .
kPassword	Controls uEFI Setup and Shell passwords This command is used to determine the status of both passwords (set or not set) and to set or clear the uEFI Shell and Setup passwords. Both user and superuser (Supervisor) passwords can be controlled with this command. Call without options to get current password status. Entering an empty password clears the password.

FUNCTION	DESCRIPTION
kReset	Controls the board's reset behavior This command controls if the board shall react on a CompactPCI backplane reset if it is used in a peripheral slot. It has no effect if the board is installed in the CompactPCI system slot. The parameter of this command is volatile and set to off at the next start.
kSelectFlash	This command is used to determine the current active boot flash. It allows also temporary switching of the boot flash during uEFI BIOS update. Refer to <i>chapter 7.5.1, 'Updating the uEFI BIOS'</i> for flash bank handling and uEFI BIOS updates. If ME is not set to recovery mode (Re-Flash enable) Firmware may malfunction if SPI bank is switched during operation.
kWatchdog	Configures the Kontron onboard watchdog This command is used to enable the Kontron onboard watchdog with reset target before OS boot. This can be used to detect if the OS fails to boot and react by reset.

7.4. uEFI Shell Scripting

7.4.1. Startup Scripting

If the ESC key is not pressed and the timeout is run out, the uEFI Shell tries to execute some startup scripts automatically. It searches for scripts and executes them in the following order:

1. Kontron flash-stored startup script (see Kontron-Specific uEFI Shell Command **kBootNsh**)
2. If there is no Kontron flash-stored startup script present, the uEFI-specified **startup.nsh** script is used. This script must be located on the root of any of the attached FAT formatted disk drive.
3. If none of the startup scripts is present or the startup script terminates, the default boot order is continued.

7.4.2. Create a Startup Script

Startup scripts can be created using the uEFI Shell built-in editor **edit** or under any OS with a plain text editor of your choice. To create a startup shell script, simply save the script on the root of any FAT-formatted drive attached to the system. To copy the startup script to the flash use the **kBootNsh** uEFI Shell command.

In case there is no mass storage device attached, the startup script can be generated in a RAM disk and stored in the SPI boot flash using the **kMkRamdisk** uEFI Shell command.

7.4.3. Examples of Startup Scripts

7.4.3.1. Execute Shell Script on Other Harddrive

This example (**startup.nsh**) executes the shell script named **bootme.nsh** located in the root of the first detected disc drive (**fs0**).

```
fs0:
bootme.nsh
```

7.4.3.2. Enable Watchdog

To enable the watchdog within a script, use the following commands (**kwatchdog -t 15** can also be used at uEFI shell prompt directly):

```
echo -off
echo "Executing sample startup.nsh..."
kwatchdog -t 15
echo "Watchdog enabled"
```

To create a uEFI Shell environment variable, use the **set** uEFI Shell command as shown below:

```
Shell> set wdt enable on
Shell> set
    wdt enable : on
Shell> reset
```

The following sample start-up script shows the uEFI Shell environment variable **wdt_enable** used to control the Watchdog.

```
echo -off
echo "Executing sample startup.nsh..."
if %wdt enable% == "on" then
    kwatchdog -t 15
    echo "Watchdog enabled"
endif
```

7.4.3.3. Handling the Startup Script in the SPI Boot Flash

In case there is no mass storage device attached, the startup script can be generated in a RAM disk and stored in the SPI boot flash using the following instructions:

1. Press <ESC> during power-up to log into the uEFI Shell.
2. Create a RAM disk and set the proper working directory as shown below:

```
Shell> kmkramdisk -s 3 myramdisk
Shell> myramdisk:
```

3. Enter the sample start-up script mentioned above in this section using the edit uEFI Shell command.

```
myramdisk:\> edit boot.nsh
```

4. Save the start-up script to the SPI boot flash using the kBootNsh uEFI Shell command.

```
myramdisk:\> kbootnsh -p boot.nsh
```

5. Reset the board to execute the newly installed script using the reset uEFI Shell command.

```
myramdisk:\> reset
```

6. If a script is already installed, it can be edited using the following kBootNsh uEFI Shell commands.

```
myramdisk:\> kbootnsh -g boot.nsh
myramdisk:\> edit boot.nsh
```

7.5. Firmware Update

7.5.1. Updating the uEFI BIOS

7.5.1.1. uEFI BIOS Fail-Over Mechanism

The CP6007 has two SPI boot flashes programmed with the uEFI BIOS, a standard SPI boot flash and a recovery SPI boot flash. The basic idea behind that is to always have at least one working uEFI BIOS flash available regardless if there have been any flashing errors or not.

7.5.1.2. Updating the uEFI BIOS

For updating the BIOS, perform the following steps:

1. Prepare FAT formatted USB Stick with files from update package
 - ▶ EtaAfuOemEfi64.efi
 - ▶ B4C01_EFI_R0xy.bi B4C01_EFI_R0xy.bin
 - ▶ update.nsh
2. Plug USB Stick into CP6007
3. Boot into uEFI Shell, enable ME-Update and boot again into uEFI Shell

```
Shell> Kboardconfig UpdateMode enabled
Shell> reset
```

Note: CP6007 performs multiple reboots, requires several minutes, be patient.

4. Check with Kboardinfo that ME has been stopped

```
Shell> Kboardinfo
....
ME State:   Stopped (0)
```

5. Navigate to folder on USB Stick where update files have been stored and start update task.
(use map -r to remap and list all devices):

```
Shell> fs0:
FS0:\> cd CP6007
FS0:\CP6007\> cd B4C01_R14
FS0:\CP6007\B4C01_R14\>update.nsh
```

6. Power the cycle the board to get new Bios Version active.
Note, be patient; reboot after ME Update requires several minutes; board will reset by itself at least two times. Verify that new Bios Version is running and ME is operational.

```
Shell> Kboardinfo
....
EFI rev.:   R014, standard
...
ME State:   Running (1)
```

7.5.1.3. uEFI BIOS Recovery

In case of the standard SPI boot flash being corrupted and therefore the board not starting up, the board can be booted from the recovery SPI boot flash if the DIP switch SW1, switch 2 is set to ON. For further information, refer to the Chapter 3.1, DIP Switch Configuration.



The uEFI BIOS code and settings are stored in the SPI boot flashes. Changes made to the uEFI BIOS settings are available only in the currently selected SPI boot flash. Thus, switching over to the other SPI boot flash may result in operation with different uEFI BIOS code and settings.

7.5.1.4. Determining the Active Flash

Sometimes it may be necessary to check which flash is active. On the uEFI BIOS, this information is available via the uEFI Shell commands: **kBoardInfo** and **kSelectFlash**.



The **kBoardInfo** uEFI Shell command always displays the SPI flash information from which the uEFI BIOS was started.



The **kSelectFlash** uEFI Shell command displays the current selected SPI boot flash. If changed after booting (e.g. via DIP switch SW3 switch 2 or the **kSelectFlash** uEFI Shell command itself)

7.5.2. Updating the IPMI Firmware

7.5.2.1. IPMI Rollback Mechanism

The CP6007 IPMI controller has an internal flash, where the boot block or the active IPMI firmware is running from, as well as an external flash, where two IPMI firmware images are stored, namely:

- ▶ a copy of the currently active image, and
- ▶ the previously good image or the newly downloaded image.

During firmware upgrade, the previously good image in the external flash is replaced by the newly downloaded image. Then the boot block activates the new image by copying it to the internal flash. If the newly downloaded image was successfully activated, its copy in the external flash is now the active image. The copy of the old active image becomes the previously good image.

Manual rollback is also possible via the **klpmi hpm rollback** uEFI Shell command.

7.5.2.2. Determining the Active IPMI Firmware Image

To determine the active IPMI firmware image, use the **klpmi info** command.

7.5.2.3. Updating Procedure

The active IPMI firmware image can be updated with the latest HPM.1 file using the **klpmi hpm upgrade** uEFI Shell command.

8/ IPMI Firmware

8.1. Overview

The CP6007 provides an IPMI controller (NXP® ARM7) with 512 kB of internal firmware flash as well as external firmware flash for firmware upgrade and rollback. The IPMI controller carries out IPMI commands such as monitoring several onboard temperature conditions, board voltages and the power supply status, and managing hot swap operations. The IPMI controller is accessible via two IPMBs, one host Keyboard Controller Style (KCS) interface and up to four Gigabit Ethernet interfaces (IOL).

The CP6007 is fully compliant with the IPMI - Intelligent Platform Management Interface v2.0 and the PICMG 2.9 R1.0 specifications.

The following are key features of the CP6007's IPMI firmware:

- ▶ Keyboard Controller Style (KCS) interface
- ▶ Dual-port IPMB interface for out-of-band management and sensor monitoring
- ▶ IPMI over LAN (IOL) and Serial over LAN (SOL) support
- ▶ Sensor Device functionality with configurable thresholds for monitoring board voltages, CPU state, board reset, etc.
- ▶ FRU Inventory functionality
- ▶ System Event Log (SEL), Event Receiver functionalities
- ▶ Sensor Data Record Repository (SDRR) functionality
- ▶ IPMI Watchdog functionality (power-cycle, reset)
- ▶ Board monitoring and control extensions:
 - ▶ Graceful shutdown support
 - ▶ uEFI BIOS fail-over control: selection of the SPI boot flash (standard/recovery)
- ▶ Field-upgradeable IPMI firmware:
 - ▶ via the KCS, IPMB or IOL interfaces
 - ▶ Download of firmware does not break the currently running firmware or payload activities
- ▶ Two flash banks with rollback capability: manual rollback or automatic in case of upgrade failure

For general information on the Kontron IPMI Firmware, refer to the IPMI Firmware User Guide.

8.2. IPMI Firmware and KCS Interface Configuration

Initially the default configuration of the IPMI firmware (KCS and IPMB interfaces) is:

- ▶ IRQ = 11
- ▶ MODE = SMC
- ▶ IPMB = single-ported.

If this is the required configuration, no further action is required. If the configuration must be modified, the **kIpmi** uEFI Shell command is used to modify the configuration as required, e.g. "klpmi irq [0|11]", "klpmi mode [smc|bmc]", and "klpmi ipmb [single-ported|dual-ported]". For information on the **kIpmi** uEFI Shell command, refer to the uEFI BIOS Chapter.

The KCS interface serves for the communication between the CP6007's payload and the IPMI controller. The IPMI OS kernel s require the KCS interface configuration during their loading time. The KCS interface configuration is available in the "IPMI Device Information Record" included in the SMBIOS table.

8.3. Supported IPMI and PICMG Commands

8.3.1. Standard IPMI Commands

The following table shows an excerpt from the command list specified in the IPMI specification 2.0. The shaded table cells indicate commands not supported by the CP6007 IPMI firmware.

M = mandatory, O = optional

Table 54: Standard IPMI Commands

COMMAND	IPMI 2.0 SPEC. SECTION	NETFN	CMD	KONTRON SUPPORT ON IPMI CONTROLLER
IPM DEVICE "GLOBAL" COMMANDS				M
Get Device ID	20.1	App	01h	M / Yes
Cold Reset	20.2	App	02h	O / Yes
Warm Reset	20.3	App	03h	O / No
Get Self Test Results	20.4	App	04h	O / Yes
Manufacturing Test On	20.5	App	05h	O / No
Set ACPI Power State	20.6	App	06h	O / Yes
Get ACPI Power State	20.7	App	07h	O / Yes
Get Device GUID	20.8	App	08h	O / No
Broadcast "Get Device ID"	20.9	App	01h	M / Yes
BMC WATCHDOG TIMER COMMANDS				O
Reset Watchdog Timer	27.5	App	22h	O / Yes
Set Watchdog Timer	27.6	App	24h	O / Yes
Get Watchdog Timer	27.7	App	25h	O / Yes
BMC DEVICE AND MESSAGING COMMANDS				O
Set BMC Global Enables	22.1	App	2Eh	O / Yes
Get BMC Global Enables	22.2	App	2Fh	O / Yes
Clear Message Flags	22.3	App	30h	O / Yes
Get Message Flags	22.4	App	31h	O / Yes
Enable Message Channel Receive	22.5	App	32h	O / Yes
Get Message	22.6	App	33h	O / Yes
Send Message	22.7	App	34h	O / Yes
Read Event Message Buffer	22.8	App	35h	O / Yes
Get BT Interface Capabilities	22.9	App	36h	O / No
Get System GUID	22.14	App	37h	O / No
Get Channel Authentication Capabilities	22.13	App	38h	O / Yes
Session Control	22.15 to 22.20	App	39h to 3Dh	O / Yes
Get AuthCode	22.21	App	3Fh	O / No
Channel Commands	22.22 to 22.30	App	40h to 47h	O / Yes
User Commands	24.1 to 24.9	App	48h to 4Fh	O / Yes
Get Channel OEM Payload Info	24.10	App	50h	O / No

COMMAND	IPMI 2.0 SPEC. SECTION	NETFN	CMD	KONTRON SUPPORT ON IPMI CONTROLLER
Master Write-Read	22.11	App	52h	0 / Yes
Get Channel Cipher Suits	22.15	App	54h	0 / No
Suspend/Resume Payload Encryption	24.3	App	55h	0 / Yes
Set Channel Security Keys	22.25	App	56h	0 / No
Get System Interface Capabilities	22.9	App	57h	0 / No
CHASSIS DEVICE COMMANDS				0
Get Chassis Capabilities	28.1	Chassis	00h	0 / Yes
Get Chassis Status	28.2	Chassis	01h	0 / Yes
Chassis Control	28.3	Chassis	02h	0 / Yes
Extended Chassis Control Commands	28.4 to 28.8	Chassis	03h, 04h, 0Ah, 05h, 06h	0 / No
Set Power Cycle Interval	28.9	Chassis	0Bh	0 / Yes
Extended Chassis Control Commands	28.11 to 28.13	Chassis	07h to 09h	0 / No
Get POH Counter	28.14	Chassis	0Fh	0 / Yes
EVENT COMMANDS				M
Set Event Receiver	29.1	S/E	00h	M / Yes
Get Event Receiver	29.2	S/E	01h	M / Yes
Platform Event (a.k.a. "Event Message")	29.3	S/E	02h	M / Yes
PEF AND ALERTING COMMANDS				0 / No
SENSOR DEVICE COMMANDS				M
Get Device SDR Info	35.2	S/E	20h	M / Yes
Get Device SDR	35.3	S/E	21h	M / Yes
Reserve Device SDR Repository	35.4	S/E	22h	M / Yes
Get Sensor Reading Factors	35.5	S/E	23h	0 / No
Set Sensor Hysteresis	35.6	S/E	24h	0 / Yes
Get Sensor Hysteresis	35.7	S/E	25h	0 / Yes
Set Sensor Threshold	35.8	S/E	26h	0 / Yes
Get Sensor Threshold	35.9	S/E	27h	0 / Yes
Set Sensor Event Enable	35.10	S/E	28h	0 / Yes
Get Sensor Event Enable	35.11	S/E	29h	0 / Yes
Re-arm Sensor Events	35.12	S/E	2Ah	0 / No
Get Sensor Event Status	35.13	S/E	2Bh	0 / No
Get Sensor Reading	35.14	S/E	2Dh	M / Yes
Set Sensor Type	35.15	S/E	2Eh	0 / No
Get Sensor Type	35.16	S/E	2Fh	0 / No
FRU DEVICE COMMANDS				M
Get FRU Inventory Area Info	34.1	Storage	10h	M / Yes
Read FRU Data	34.2	Storage	11h	M / Yes
Write FRU Data	34.3	Storage	12h	M / Yes
SDR DEVICE COMMANDS				0

COMMAND	IPMI 2.0 SPEC. SECTION	NETFN	CMD	KONTRON SUPPORT ON IPMI CONTROLLER
Get SDR Repository Info	33.9	Storage	20h	0 / Yes
Get SDR Repository Allocation Info	33.10	Storage	21h	0 / Yes
Reserve SDR Repository	33.11	Storage	22h	0 / Yes
Get SDR	33.12	Storage	23h	0 / Yes
Add SDR	33.13	Storage	24h	0 / Yes
Partial Add SDR	33.14	Storage	25h	0 / Yes
Delete SDR	33.15	Storage	26h	0 / Yes
Clear SDR Repository	33.16	Storage	27h	0 / Yes
Get SDR Repository Time	33.17	Storage	28h	0 / No
Set SDR Repository Time	33.18	Storage	29h	0 / No
Enter SDR Repository Update Mode	33.19	Storage	2Ah	0 / No
Exit SDR Repository Update Mode	33.20	Storage	2Bh	0 / No
Run Initialization Agent	33.21	Storage	2Ch	0 / Yes
SEL DEVICE COMMANDS				0
Get SEL Info	40.2	Storage	40h	0 / Yes
Get SEL Allocation Info	40.3	Storage	41h	0 / Yes
Reserve SEL	40.4	Storage	42h	0 / Yes
Get SEL Entry	40.5	Storage	43h	0 / Yes
Add SEL Entry	40.6	Storage	44h	0 / Yes
Partial Add SEL Entry	40.7	Storage	45h	0 / No
Delete SEL Entry	40.8	Storage	46h	0 / Yes
Clear SEL	40.9	Storage	47h	0 / Yes
Get SEL Time	40.10	Storage	48h	0 / Yes
Set SEL Time	40.11	Storage	49h	0 / Yes
Get Auxiliary Log Status	40.12	Storage	5Ah	0 / No
Set Auxiliary Log Status	40.13	Storage	5Bh	0 / No
LAN DEVICE COMMANDS				0
Set LAN Configuration Parameters	23.1	Transport	01h	0 / Yes
Get LAN Configuration Parameters	23.2	Transport	02h	0 / Yes
Suspend BMC ARPs	23.3	Transport	03h	0 / No
Get IP/UDP/RMCP Statistics	23.4	Transport	04h	0 / Yes
SERIAL/MODEM DEVICE COMMANDS	25.1 to 25.12	Transport	10h to 1Bh	0 / No
SOL COMMANDS				0
SOL Activating	26.1	Transport	20h	0 / Yes
Set SOL Configuration Parameters	26.2	Transport	21h	0 / Yes
Get SOL Configuration Parameters	26.3	Transport	22h	0 / Yes

NOTICE

Some of the above-mentioned commands, such as SDR device commands, work only if the IPMI controller is configured as BMC. For further information, refer to the IPMI specification 2.0.

8.3.2. PICMG Commands

The following table shows an excerpt from the command list specified in the PICMG 3.0 R 2.0 AdvancedTCA Base Specification and the PICMG AMC.0 Advanced Mezzanine Card Specification, R 1.0. The shaded table cells indicate commands not supported by the IPMI firmware.

M = mandatory

Table 55: Supported PICMG Commands

COMMAND	PICMG SPEC. SECTION	NETFN	CMD	KONTRON SUPPORT ON IPMI CONTROLLER
Get PICMG Properties	3-9	PICMG	00h	M / Yes
FRU Control	3-22	PICMG	04h	N/A
Get FRU LED Properties	3-29	PICMG	05h	M / Yes
Get LED Color Capabilities	3-25	PICMG	06h	M / Yes
Set FRU LED State	3-26	PICMG	07h	M / Yes
Get FRU LED State	3-27	PICMG	08h	M / Yes
Get Device Locator Record ID	3-29	PICMG	0Dh	M / Yes

8.4. Firmware Identification

8.4.1. Get Device ID Command

Table 56: Get Device ID Command

COMMAND		LUN	NetFn	CMD
Get Device ID		00h	App = 06h	01h
REQUEST DATA				
Byte	Data Field			
--	--			
RESPONSE DATA				
Byte	Data Field			
1	Completion code			
2	10h	Device ID		
3	00h	Device Revision		
4	02h	Firmware Revision 1: Major Firmware Revision (varies depending on firmware revision)		
5	00h	Firmware Revision 2: Minor Firmware Revision, BCD encoded (varies depending on firmware revision)		
6	51h	IPMI Version, holds IPMI command specification version, BCD encoded		
7	BDh or BFh	Additional Device Support (SMC or BMC mode)		
8..10	98h 3Ah 00h	Manufacturer ID, LSB first 03A98h = 15000 = Kontron		
11..12	C0h B4h	Product ID, LSB first B4C0h = Identifies the board/family firmware		
13*	Release number of the IPMI firmware (varies depending on firmware revision): 10h for R10 11h for R11			
14*	Board Geographical Address/slot number: 1 ... = Board in chassis slot 1...			
15..16*	Reserved			

* Bytes 13 through 16 are optional and defined by Kontron.

Invoking the IPMI command **Get Device ID** returns among other information the following data:

- ▶ Manufacturer ID = 3A98h (Kontron IANA ID)
- ▶ Product ID = B4C0h, identifies the board family of the IPMI firmware
- ▶ Firmware revision (byte 4:5) reflects the version of the running firmware, which will change after firmware update.
- ▶ Release number of the IPMI firmware (byte 13) will be incremented with each firmware update

8.4.2. Device Locator Record

The device ID string which can be found by reading the Device Locator Record (SDR Type 12h) contains the string "BMC:x ... x". For example, invoking the "ipmitool" command `ipmitool sdr list mcloc` will return the device ID strings of all available boards. If the IPMI controller is in BMC mode, this string will be displayed without change. If the IPMI controller is in SMC mode, then the string will be changed into "Sxx: x ... x" where xx is the slot number where the board is residing, e.g. "S09: x ... x".

8.5. Board Control Extensions

8.5.1. SPI Boot Flash Selection—uEFI BIOS Failover Control (OPEN)

The uEFI BIOS code is stored in two different SPI boot flash devices designated as the standard SPI boot flash and the recovery SPI boot flash.

By default, the uEFI BIOS code stored in the standard SPI boot flash is executed first. If this fails, the uEFI BIOS code in the recovery SPI boot flash is then executed.

During boot-up, the uEFI BIOS reports its operational status to the IPMI controller within a given time. If the status is "failed" or not reported within the given time, the IPMI controller selects the recovery SPI boot flash, resets the board's processor, and waits for the status report from the uEFI BIOS again.

During boot-up, the uEFI BIOS reports its operational status to the IPMI controller within a given time. If the status is "failed" or not reported within the given time, a "Boot Error - Invalid boot sector" event is asserted.

In the event the recovery boot operation fails, the IPMI controller reports it, but takes no further action of its own.

When a boot operation fails, a "Boot Error - Invalid boot sector" event is asserted for the related sensor:

- ▶ "FWH0 Boot Err" sensor indicates the standard SPI boot flash has failed
- ▶ "FWH1 Boot Err" sensor indicates the recovery SPI boot flash has failed

8.6. Sensors Implemented on the Board

The IPMI controller includes several sensors for voltage or temperature monitoring and various others for pass/fail type signal monitoring. Every sensor is associated with a Sensor Data Record (SDR). Sensor Data Records contain information about the sensor's identification such as sensor type, sensor name, and sensor unit. SDRs also contain the configuration of a specific sensor such as threshold, hysteresis or event generation capabilities that specify the sensor's behavior. Some fields of the sensor SDR are configurable using IPMI commands, others are always set to built-in default values.

The IPMI controller supports sensor device commands and uses the static sensor population feature of IPMI. All Sensor Data Records can be queried using Device SDR commands.

The sensor name (ID string) has a name prefix which is 'NNN:' in the lists below. When reading the sensor name after board insertion, this prefix becomes automatically adapted to the role (BMC or SMC) and the physical position (slot number) of the board in a rack. If the IPMI controller is set up as a BMC, the prefix will be 'BMC:' independent of the slot where it resides. If the IPMI controller is set up as an SMC, the prefix will be 'Sxx:' where xx is the slot number (e.g. 09).

The sensor number is the number which identifies the sensor e.g. when using the IPMI command `Get Sensor Reading`. Please note that "ipmitool" accepts sensor numbers in decimal (e.g. "10") or hexadecimal (e.g. "0xa") notation.

The IPMI tool "ipmitool" displays for the command "ipmitool sdr list" the contents of the sensor data record repository (SDRR) of the whole rack if the SDRR has been generated. The generation of the SDRR must always be redone after adding or removing a board from the rack. For further information, refer to the *IPMI Firmware User Guide*, section "IPMI Setup for the Rack".

8.6.1. Sensor List

The following table indicates all sensors available on the CP6007. For further information on Kontron's OEM-specific sensor types and sensor event type codes presented in the following table, refer to section "OEM Event/Reading Types".

Table 57: Sensor List

SENSOR NUMBER / ID STRING	SENSOR TYPE (CODE) / EVENT/READING TYPE (CODE)	Assertion Mask / Deassertion Mask/ Reading Mask	DESCRIPTION	LED I1 Active / Reading Mask
00h / NNN:Hot Swap	Hot Swap (F0h) / Sensor-specific (6Fh)	00FFh / 0000h / 00FFh	Hot swap sensor	N
01h / NNN:Temp CPU	Temperature (01h) / Threshold (01h)	1A81h / 7A81h / 3939h	CPU die temperature	Y / 0F3Ch
03h / NNN:Temp Board	Temperature (01h) / Threshold (01h)	7A95h / 7A95h / 3F3Fh	Board temperature	Y / 0F3Ch
04h / NNN:Pwr Good	Power supply (08h) / OEM (73h)	0000h / 0000h / 009Fh	Status of all power lines	N
05h / NNN:Pwr Good Evt	Power supply (08h) / OEM (73h)	009Fh / 009Fh / 009Fh	Power fail events for all power lines	Y / 009Fh
06h / NNN:Board 3.3V	Voltage (02h) / Threshold (01h)	2204h / 2204h / 1212h	Board 3.3V supply	Y / 0F3Ch
07h / NNN:Board 5VIPMI	Voltage (02h) / Threshold (01h)	2204h / 2204h / 1212h	Management Power (MP) 5V	Y / 0F3Ch
08h / NNN:Board 5.0V	Voltage (02h) / Threshold (01h)	2204h / 2204h / 1212h	Board 5V supply	Y / 0F3Ch
09h / NNN:Board 12V	Voltage (02h) / Threshold (01h)	2204h / 2204h / 1212h	Board 12V supply	Y / 0F3Ch
0Ah / NNN:IPMB 5V	Voltage (02h) / Threshold (01h)	2204h / 2204h / 1212h	IPMB 5V supply	N
0Bh / NNN:Fan1 Speed	Fan (04h) / Threshold (01h)	0000h / 0000h / 1B1Bh	Speed [rpm] Fan 1	N
0Ch / NNN:Fan2 Speed	Fan (04h) / Threshold (01h)	0000h / 0000h / 1B1Bh	Speed [rpm] Fan 2	N
0Dh / NNN>Last Reset	OEM (CFh) / "digital" Discrete (03h)	0002h / 0000h / 0003h	Board reset event	Y / 0002h
0Eh / NNN:Slot System	Entity presence (25h) / Sensor-specific (6Fh)	0000h / 0000h / 0003h	Board is in system slot (SYSEN)	N
0Fh / NNN:PCI Present	Entity presence (25h) / Sensor-specific (6Fh)	0000h / 0000h / 0003h	Board is selected (BDSEL) and in system slot (SYSEN)	N
11h / NNN:IPMI WD	Watchdog2 (23h) / Sensor-specific (6Fh)	010Fh / 0000h / 010Fh	IPMI watchdog	Y / 010Fh
12h / NNN:IPMB State	IPMB status change (F1h) / Sensor-specific (6Fh)	000Fh / 0000h / 000Fh	IPMB-0 state (refer to PICMG 3.0 Rev 2.0, 3.8.4.1)	N

SENSOR NUMBER / ID STRING	SENSOR TYPE (CODE) / EVENT/READING TYPE (CODE)	Assertion Mask / Deassertion Mask/ Reading Mask	DESCRIPTION	LED I1 Active / Reading Mask
13h / NNN:ACPI State	System ACPI Power State (22h) / Sensor-specific (6Fh)	7FFFh / 0000h / 7FFFh	System ACPI power state	N
14h / NNN:Health Error	Platform Alert (24h) / "digital" Discrete (03h)	0000h / 0000h / 0003h	Aggregates states (power, temperatures etc.). Visualization by the Health LED (LED I1, red).	N
15h / NNN:CPU 0 Status	Processor (07h) / Sensor-specific (6Fh)	0463h / 0400h / 04E3h	CPU status: "Processor Throttled, THERMTRIP or CAT error"	Y / 0403h
16h / NNN:POST Value	POST value OEM (C6h) / Sensor-specific (6Fh)	4000h / 0000h / 40FFh	POST code value (port 80h)	N
17h / NNN:FWHO BootErr	Boot error (1Eh) / Sensor-specific (6Fh)	0008h / 0008h / 0008h	Boot error on standard SPI boot flash	Y / 0008h
18h / NNN:FWH1 BootErr	Boot error (1Eh) / Sensor-specific (6Fh)	0008h / 0008h / 0008h	Boot error on recovery SPI boot flash	Y / 0008h
19h / NNN:XMC present	Entity Presence (25h) / Sensor-specific (6Fh)	0000h / 0000h / 0003h	Presence of XMC board	N
1Ah / NNN:FRU Agent	OEM FRU Agent (C5h) / Discrete (0Ah)	0140h / 0000h / 0147h	FRU initialization agent state	Y / 0140h
1Bh / NNN:IPMC Storage	Management Subsystem Health (28h) / Sensor-specific (6Fh)	0002h / 0000h / 0003h	IPMI controller storage access error	Y / 0002h
1Ch / NNN:IPMC Reboot	Platform Alert (24h) / "digital" Discrete (03h)	0002h / 0000h / 0003h	2 = (Re-) Boot of IPMI controller	N
1Dh / NNN:IPMC FwUp	OEM FW Update (C7h) / Sensor-specific (6Fh)	010Fh / 0000h / 10Fh	IPMI FW update / manual rollback / automatic rollback	N
1Eh / NNN:Ver change	Firmware version changed (2Bh) / Sensor-specific (6Fh)	0002h / 0000h / 0002h	IPMI FW version, uEFI BIOS version, and logic version changed; update sensor data record repository	N
1Fh / NNN:SEL State	Event Logging Disabled (10h) / Sensor-specific (6Fh)	003Ch / 0000h / 003Ch	State of event logging	N
20h / NNN:IPMI Info-1	OEM Firmware Info 1 (C0h) / OEM (70h)	0003h / 0000h / 7FFFh	For internal use only	N
21h / NNN:IPMI Info-2	OEM Firmware Info 2 (C0h) / OEM (71h)	0003h / 0000h / 7FFFh	For internal use only	N

SENSOR NUMBER / ID STRING	SENSOR TYPE (CODE) / EVENT/READING TYPE (CODE)	Assertion Mask / Deassertion Mask/ Reading Mask	DESCRIPTION	LED I1 Active / Reading Mask
22h / NNN:IniAgent Err	Initialization Agent (C2h) / "digital" Discrete (03h)	0002h / 0000h / 0003h	Initialization agent error status. Used on BMC only. 1 = error free	Y / 0002h
23h / NNN:Board Rev	OEM Board Revision (CEh)/ Sensor-specific (6Fh)	0000h / 0000h / 7FFFh	Board revision information	N
28h / NNN:Link-LPa	LAN (27h) / Sensor-specific (6Fh)	0000h / 0000h / 0003h	LAN link status of the rear I/O port PICMG 2.16 LPa	N
29h / NNN:Link-LPb	LAN (27h) / Sensor-specific (6Fh)	0000h / 0000h / 0003h	LAN link status of the rear I/O port PICMG 2.16 LPb	N
2Ah / NNN:Link-LPc (CP6007-RA only)	LAN (27h) / Sensor-specific (6Fh)	0000h / 0000h / 0003h	LAN link status of the rear I/O port LPc CP6007-RA only	N
2Bh / NNN:Link-LPd (CP6007-RA only)	LAN (27h) / Sensor-specific (6Fh)	0000h / 0000h / 0003h	LAN link status of the rear I/O port LPd CP6007-RA only	N

8.7. Sensor Thresholds

Table 58: Thresholds – Standard Temperature Range (CP6007-SA) and Extended Temperature Range (CP6007-RA)

Sensor Number / ID String	01h / NNN:Temp CPU (CP6007-SA/RA)	03h / NNN:Temp Board (0°C to +60°C) (CP6007-SA)	03h / NNN:Temp Board (-40°C to +70°C) (CP6007-RA)
Upper non-recoverable	114 °C	85 °C	95 °C
Upper critical	104 °C	80 °C	90 °C
Upper non-critical	94 °C	70 °C	80 °C
Normal max.	85 °C	65 °C	75 °C
Nominal	75 °C	55 °C	65 °C
Normal min.	3 °C	0 °C	0 °C
Lower non-critical	1 °C	- 1 °C	- 40 °C
Lower critical	n.a.	- 2 °C	- 42 °C
Lower non-recoverable	n.a.	- 5 °C	- 45 °C

Table 59: Voltage Sensor Thresholds

Sensor Number / ID String	06h / NNN:Board 3.3V	07h / NNN:Board 5VIPMI	08h / NNN:Board 5.0V	09h / NNN:Board 12V	0Ah / NNN:IPMB 5V
Upper non-recoverable	n.a.	n.a.	n.a.	n.a.	n.a.
Upper critical	3.50 V	5.29 V	5.29 V	12.9 V	5.29 V
Upper non-critical	n.a.	n.a.	n.a.	n.a.	n.a.
Normal max.	3.47 V	5.25 V	5.25 V	12.7 V	5.25 V
Nominal	3.30 V	5.00 V	5.00 V	12.0 V	5.0 V
Normal min.	3.14 V	4.51 V	4.75 V	11.5 V	4.75 V
Lower non-critical	n.a.	n.a.	n.a.	n.a.	n.a.
Lower critical	3.11 V	4.47 V	4.71 V	11.3 V	4.71 V
Lower non-recoverable	n.a.	n.a.	n.a.	n.a.	n.a.

8.8. OEM Event/Reading Types

OEM (Kontron) specific sensor types and codes are presented in the following table.

Table 60: OEM Event/Reading Types

OEM SENSOR TYPE (CODE)	OEM EVENT/READING TYPE (CODE)	DESCRIPTION
Firmware Info 1 (C0h)	70h	Internal Diagnostic Data
Firmware Info 2 (C0h)	71h	Internal Diagnostic Data
Initialization Agent (C2h)	03h ("digital" Discrete)	Offsets / events: 0: Initialization O.K. 1: Initialization Error
FRU Agent (C5h)	0Ah (Discrete)	FRU initialization agent, using a standard reading type.
Post Value (C6h)	6Fh (sensor type specific)	Error is detected if the POST code is != 0 and doesn't change for a defined amount of time. In case of no error: Bits [7:0] = POST code (payload Port 80h) In case of error: Bits [15:0] = 4000h Data2 = POST code, low nibble Data3 = POST code, high nibble
Firmware Upgrade Manager (C7h)	6Fh (sensor type specific)	Offsets / events: 0: First Boot after upgrade 1: First Boot after rollback (error) 2: First Boot after errors (watchdog) 3: First Boot after manual rollback 4..7: Reserved 8: Firmware Watchdog Bite, reset occurred
Board Reset (CFh)	03h ("digital" Discrete)	Data 2 contains the reset type: ...WARM = 0 ...COLD = 1 ...FORCED_COLD = 2 ...SOFT_RESET = 3 ...MAX = 4 Data 3 contains the reset source: ...IPMI_WATCHDOG = 0 ...IPMI_COMMAND = 1 ...PROC_INT_CHECKSTOP = 2 ...PROC_INT_RST = 3 ...RESET_BUTTON = 4 ...POWER_UP = 5 ...LEG_INITIAL_WATCHDOG = 6 ...LEG_PROG_WATCHDOG = 7 ...SOFTWARE_INITIATED = 8 ...SETUP_RESET = 9 ...UNKNOWN = 0xFF

OEM SENSOR TYPE (CODE)	OEM EVENT/ READING TYPE (CODE)	DESCRIPTION	
e.g. for Power Good / Power Good Event	73h	Sensor-specific Offset	Event
		0h	HS fault#
		1h	HS early fault#
		2h	DEG#
		3h	FAL#
		4h	BDSELState
		5h..6h	n.a.
		7h	vccMainGood
		8h..Eh	n.a.
Board revision (CEh)	6Fh (sensor type specific)	Bits [7:0] = Board Revision number	

8.9. IPMI Firmware Code

8.9.1. Firmware Upgrade

The IPMI's operational code can be upgraded via the open-source tool "ipmitool" or via uEFI BIOS commands. The upgrade tool/commands allow download and activation of new operational code and also rollback to the "last known good" operational code. For further information on the IPMI firmware upgrade, refer to the uEFI BIOS Chapter in this manual and the IPMI Firmware User Guide.

8.9.2. IPMI Firmware and FRU Data Write Protection

If the board is plugged in a write-protected CompactPCI slot, neither the IPMI firmware or the FRU data can be updated or reprogrammed. The IPMI firmware stores the write protect state in it's local NV-RAM.

NOTICE

The write protection mode is still active when the payload is off even if the IPMI firmware reboots. To disable the write protection mode, plug the board in a non-write-protected CompactPCI slot and switch on the payload.

8.10. LAN Functions

Four Gigabit Ethernet channels on the board support IPMI over LAN (IOL) and Serial over LAN (SOL). While IOL serves to transport IPMI commands and their responses via Gigabit Ethernet, SOL serves to transport any serial data via Gigabit Ethernet.

Please note that IOL and SOL need the Ethernet device to be powered. Therefore, the board (payload) must be fully powered.

For information on the assignment of the IOL/SOL channels, refer to the "Gigabit Ethernet" section in the "Functional Description" chapter.

9/ Technical Support

For technical support contact our Support department:

- ▶ E-mail: support@kontron.com
- ▶ Phone: +49-821-4086-888

Make sure you have the following information available when you call:

- ▶ Product ID Number (PN),
- ▶ Serial Number (SN)



The serial number can be found on the Type Label, located on the product's rear side.

Be ready to explain the nature of your problem to the service technician.

9.1. Warranty

Due to their limited service life, parts that by their nature are subject to a particularly high degree of wear (wearing parts) are excluded from the warranty beyond that provided by law. This applies to the CMOS battery, for example.



If there is a protection label on your product, then the warranty is lost if the product is opened.

9.2. Returning Defective Merchandise

All equipment returned to Kontron must have a Return of Material Authorization (RMA) number assigned exclusively by Kontron. Kontron cannot be held responsible for any loss or damage caused to the equipment received without an RMA number. The buyer accepts responsibility for all freight charges for the return of goods to Kontron's designated facility. Kontron will pay the return freight charges back to the buyer's location in the event that the equipment is repaired or replaced within the stipulated warranty period. Follow these steps before returning any product to Kontron.

1. Visit the RMA Information website:
<http://www.kontron.com/support-and-services/support/rma-information>

Download the RMA Request sheet for **Kontron Europe GmbH** and fill out the form. Take care to include a short detailed description of the observed problem or failure and to include the product identification Information (Name of product, Product number and Serial number). If a delivery includes more than one product, fill out the above information in the RMA Request form for each product.

2. Send the completed RMA-Request form to the fax or email address given below at Kontron Europe GmbH. Kontron will provide an RMA-Number.

Kontron Europe GmbH
RMA Support
Phone: +49 (0) 821 4086-0
Fax: +49 (0) 821 4086 111
Email: service@kontron.com

3. The goods for repair must be packed properly for shipping, considering shock and ESD protection.



Goods returned to Kontron Europe GmbH in non-proper packaging will be considered as customer caused faults and cannot be accepted as warranty repairs.

4. Include the RMA-Number with the shipping paperwork and send the product to the delivery address provided in the RMA form or received from Kontron RMA Support.

Appendix A: List of Acronyms

Table 61: List of Acronyms

ACPI	Advanced Configuration Power Interface	HDA	High Definition Audio (HD Audio)
API	Application Programming Interface	HD/HDD	Hard Disk /Drive
Basic Module	COM Express® 125 x 95 Module form factor	HDMI	High Definition Multimedia Interface
BIOS	Basic Input Output System	HPM	PICMG Hardware Platform Management specification family
BMC	Base Management Controller	I2C	Inter integrated Circuit Communications
BSP	Board Support Package	IOL	IPMI-Over-LAN
CAN	Controller-area network	IOT	Internet of Things
Carrier Board	Application specific circuit board that accepts a COM Express® module	IPMI	Intelligent Platform Management Interface
COM	Computer-on-Module	KCS	Keyboard Controller Style
Compact Module	COM Express® 95x95 Module form factor	KVM	Keyboard Video Mouse
CNTG	Computer Network Transaction Group	LAN	Local Area Network
DDC	Display Data Control	LPC	Low Pin-Count Interface:
DDI	Digital Display Interface –	LVDS	Low Voltage Differential Signaling –
DIMM	Dual In-line Memory Module	M.A.R.S.	Mobile Application for Rechargeable Systems
Display Port	DisplayPort (digital display interface standard)	MEI	Management Engine Interface (aka: ME)
DMA	Direct Memory Access	Mini Module	COM Express® 84x55mm Module form factor
DRAM	Dynamic Random Access Memory	MTBF	Mean Time Before Failure
DVI	Digital Visual Interface	NA	Not Available
EAPI	Embedded Application Programming Interface	NC	Not Connected
ECC	Error Checking and Correction	NCSI	Network Communications Services Interface
EEPROM	Electrically Erasable Programmable Read-Only Memory	PATA	Parallel AT Attachment
eDP	Embedded Display Port	PCI	Peripheral Component Interface
EMC	Electromagnetic Compatibility (EMC)	PCIe	PCI-Express
ESD	Electro Sensitive Device	PCN	Product Change Notification
Extended Module	COM Express® 155mm x 110mm Module form factor.	PECI	Platform Environment Control Interface
FIFO	First In First Out	PEG	PCI Express Graphics
FRU	Field Replaceable Unit	PICMG®	PCI Industrial Computer Manufacturers Group
Gb	Gigabit	PHY	Ethernet controller physical layer device
GBE	Gigabit Ethernet	Pin-out Type	COM Express® definitions for signals on COM Express® Module connector pins.
GPI	General Purpose Input	PS2	Personal System 2 (keyboard & mouse)
GPIO	General Purpose Input Output	PSU	Power Supply Unit
GPO	General Purpose Output	RoHS	Restriction of Hazardous Substances
GPU	Graphics Processing Unit	RTC	Real Time Clock
HBR2	High Bitrate 2		

SAS	Serial Attached SCSI – high speed serial version of SCSI
SATA	Serial AT Attachment:
SCSI	Small Computer System Interface
SEL	System Event Log
ShMC	Shelf Management Controller
SMBus	System Management Bus
SO-DIMM	Small Outline Dual in-line Memory Module
SOIC	Small Outline Integrated Circuit
SOL	Serial Over LAN
SPI	Serial Peripheral Interface
SSH	Secure Shell
TPM	Trusted Platform Module
UART	Universal Asynchronous Receiver Transmitter
UEFI	Unified Extensible Firmware Interface
UHD	Ultra High Definition
USB	Universal Serial Bus
VGA	Video Graphics Adapter
VLP	Very Low Profile
WDT	Watch Dog Timer
WEEE	Waste Electrical and Electronic Equipment (directive)



About Kontron

Kontron is a global leader in IoT/Embedded Computing Technology (ECT). Kontron offers individual solutions in the areas of Internet of Things (IoT) and Industry 4.0 through a combined portfolio of hardware, software and services. With its standard and customized products based on highly reliable state-of-the-art technologies, Kontron provides secure and innovative applications for a wide variety of industries. As a result, customers benefit from accelerated time-to-market, lower total cost of ownership, extended product lifecycles and the best fully integrated applications.

For more information, please visit: www.kontron.com

GLOBAL HEADQUARTERS

KONTRON EUROPE GMBH

Gutenbergstraße 2
85737 Ismaning
Germany
Tel.: + 49 821 4086-0
Fax: + 49 821 4086-111
info@kontron.com